

LUMINA

Installation manual

Dimensions:
200x200 cm
200x250 cm

Handedness:
Right



Leave space for better assembly

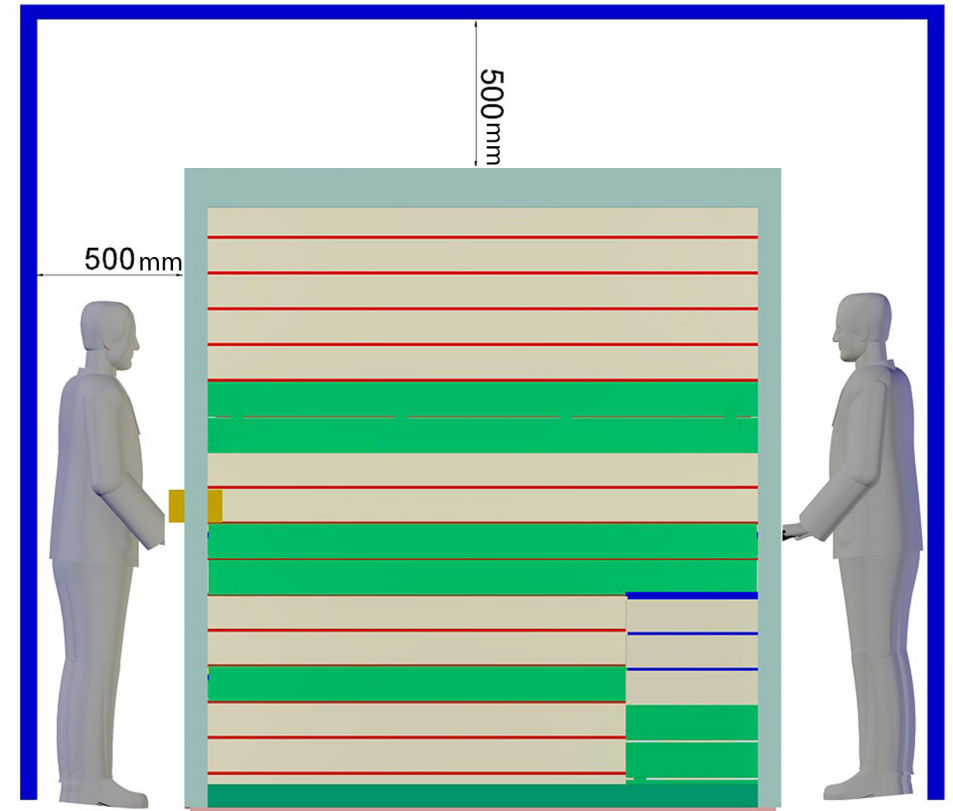
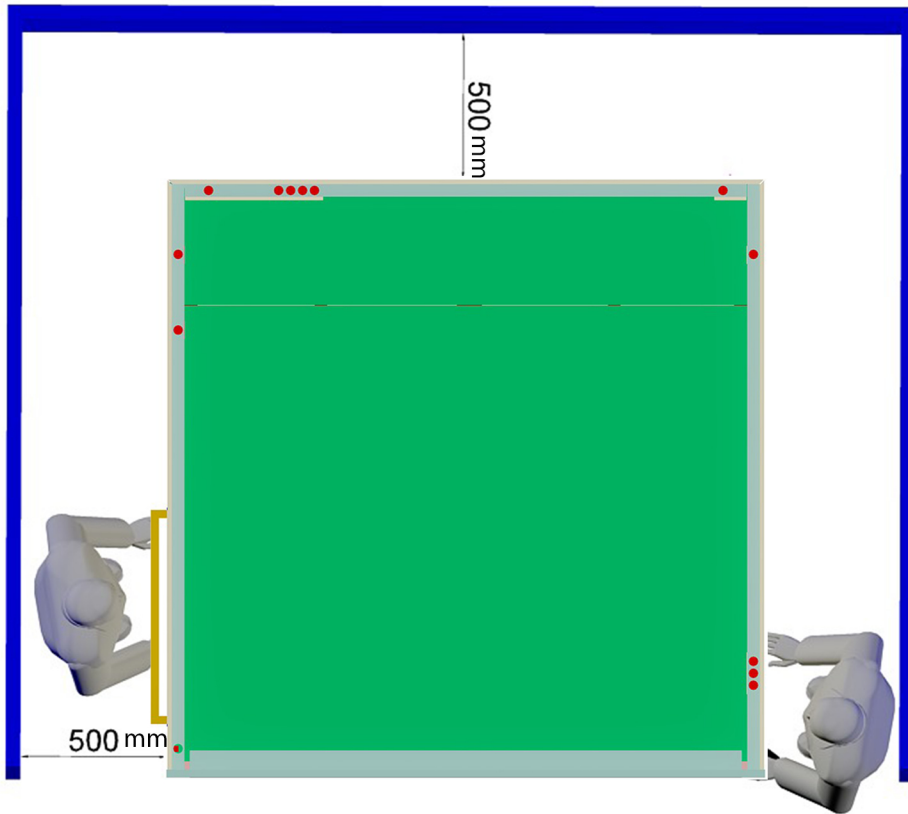

Tools

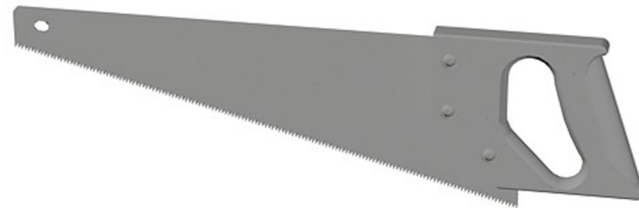
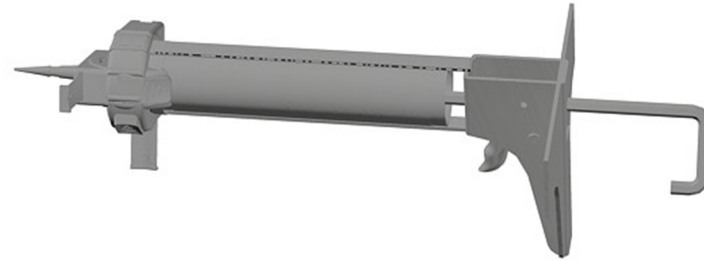

1. Base frame

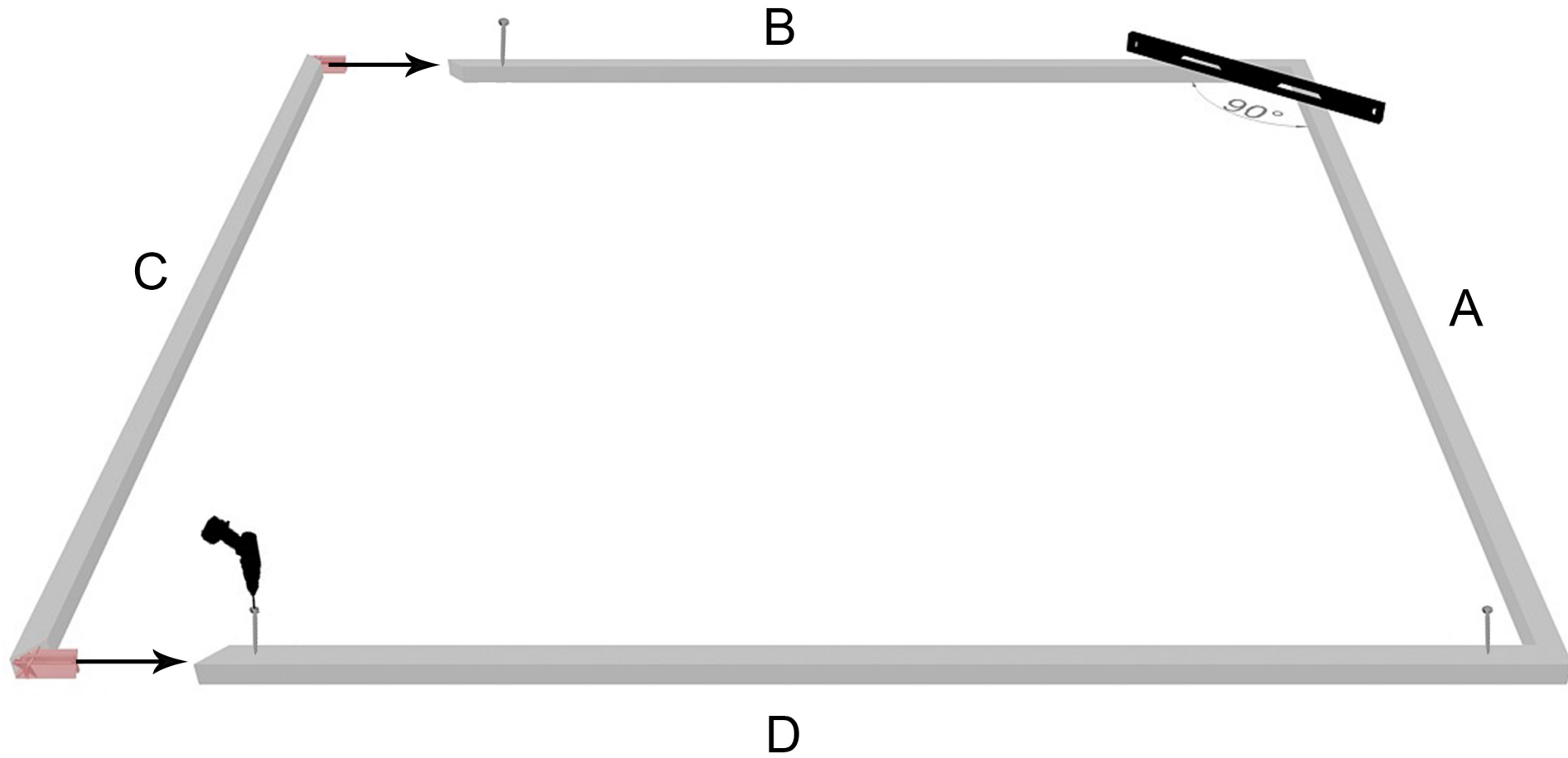

| | A/C(mm) | B/D(mm) |
|------------|---------|---------|
| 200x200 cm | 1978 | 1970 |
| 200x250 cm | 1978 | 2470 |

2. Walls

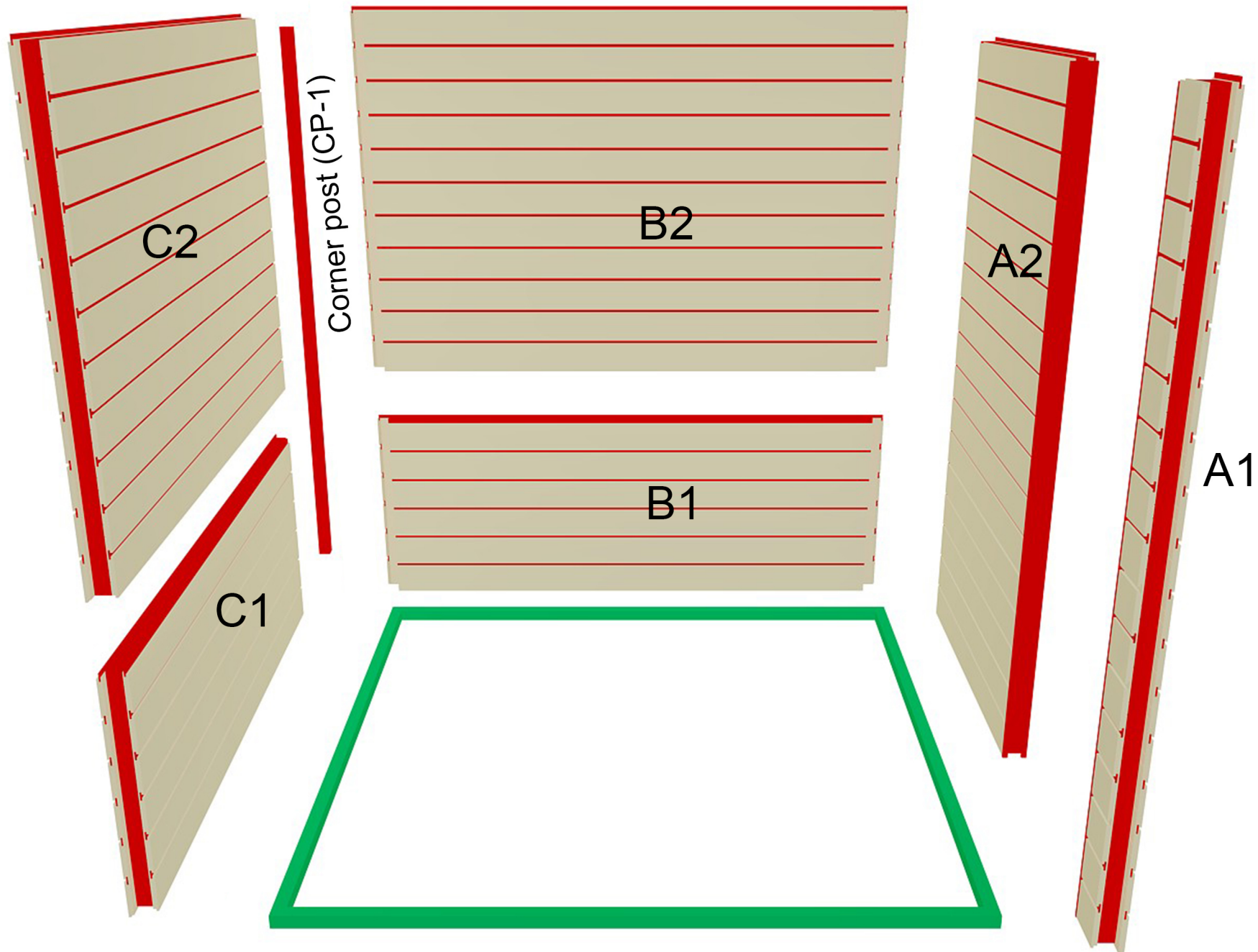

3. Multiclip closing system

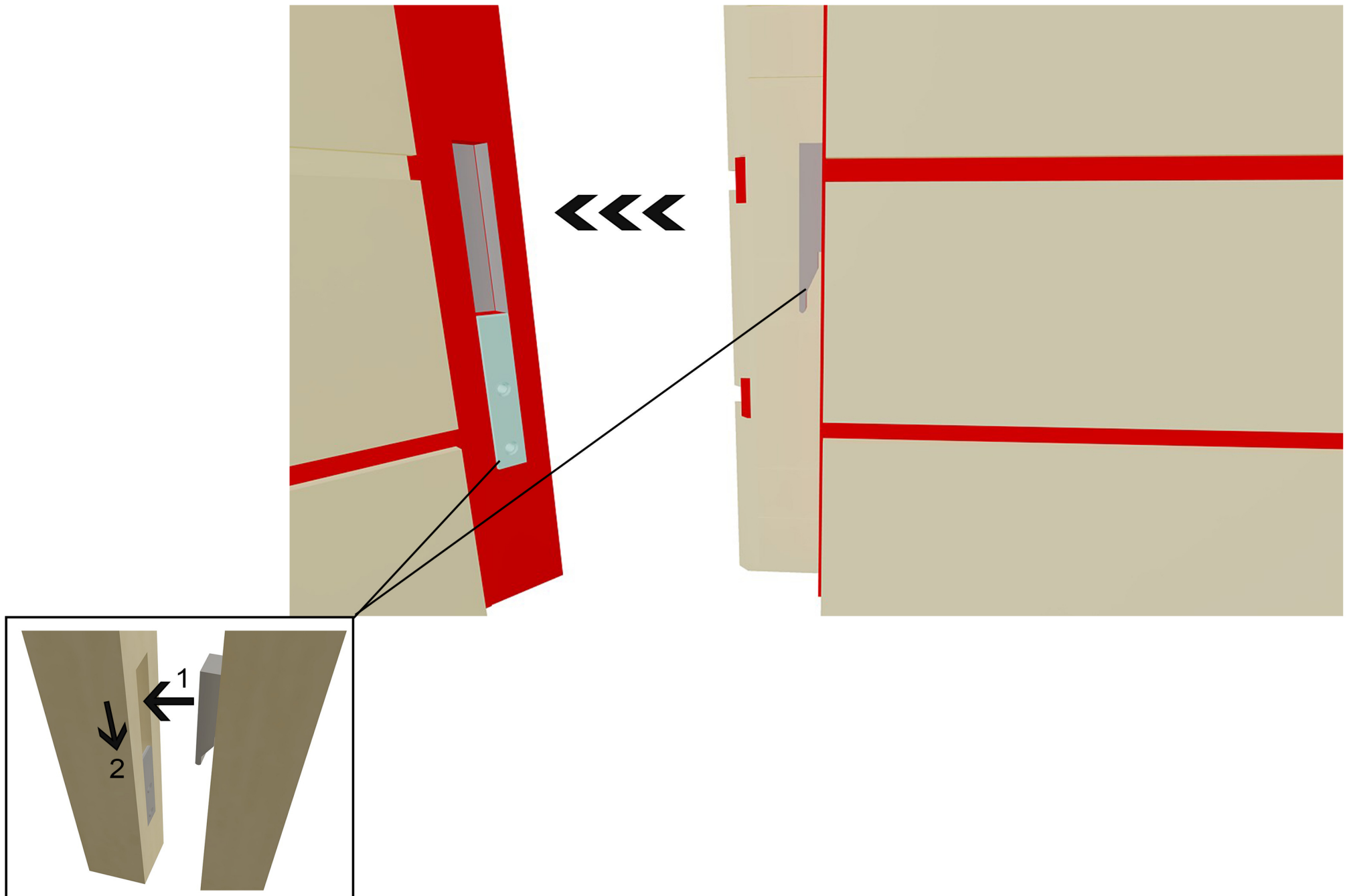

4. Fixing walls A2 & B1

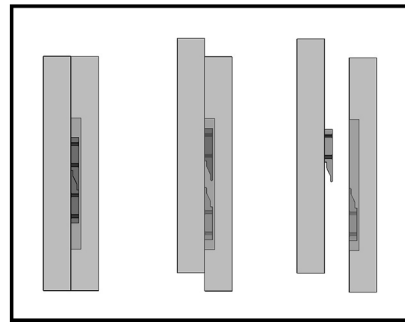
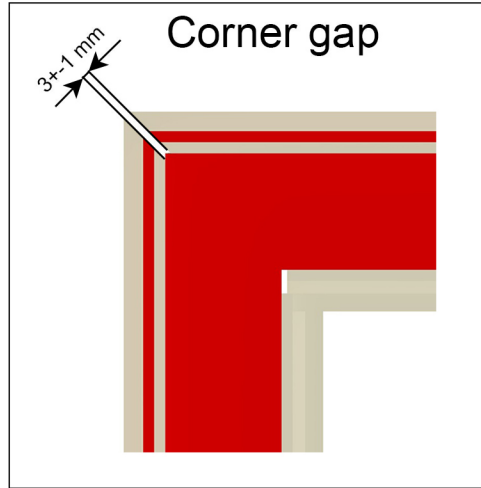

No. 1 (5x80)

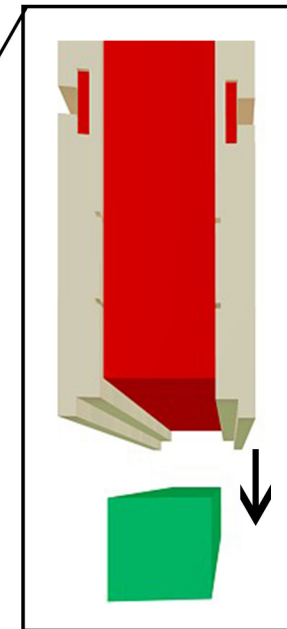
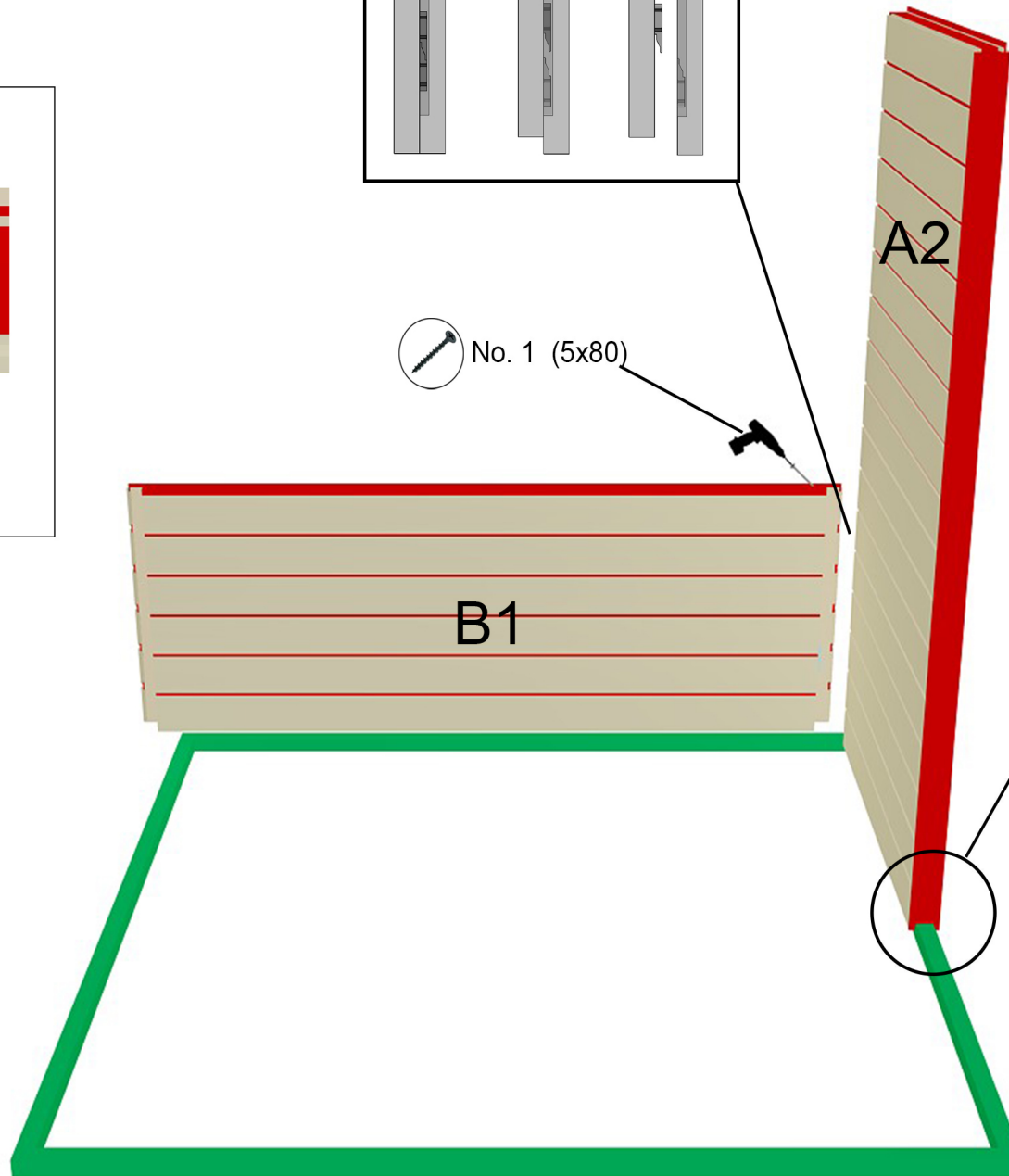

5. Fixing wall B2

No. 1 (5x80)

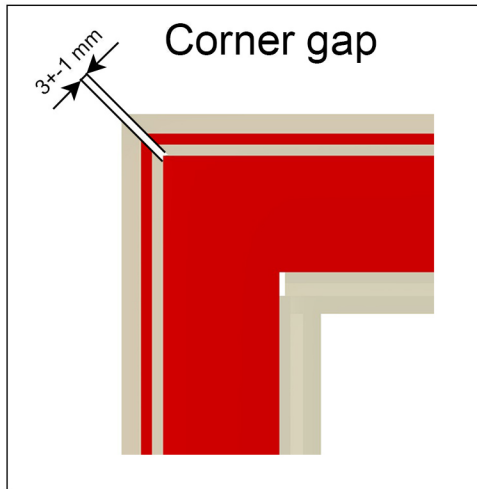
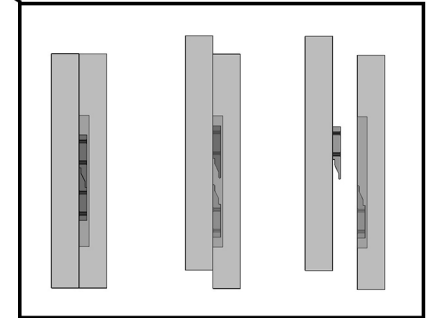
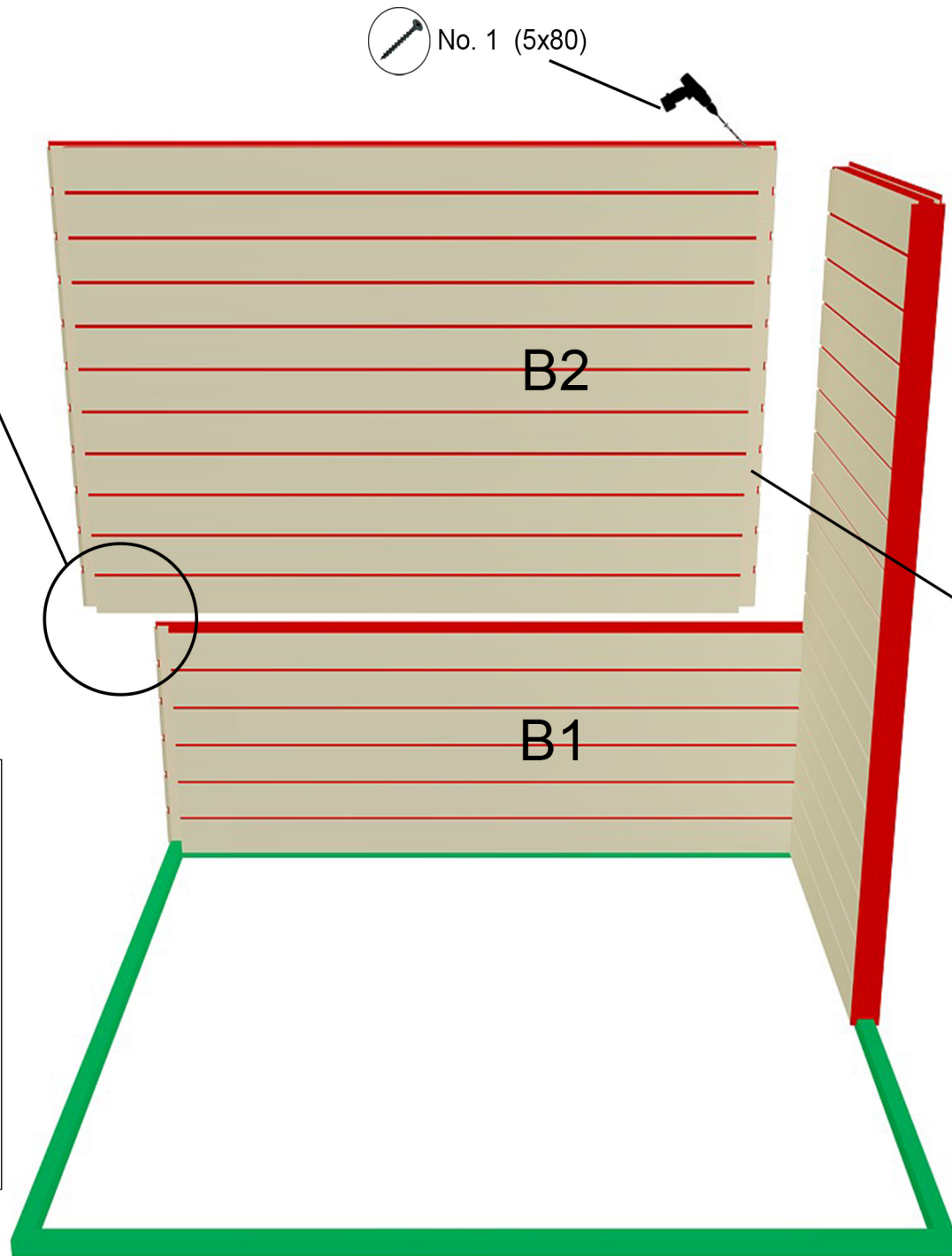
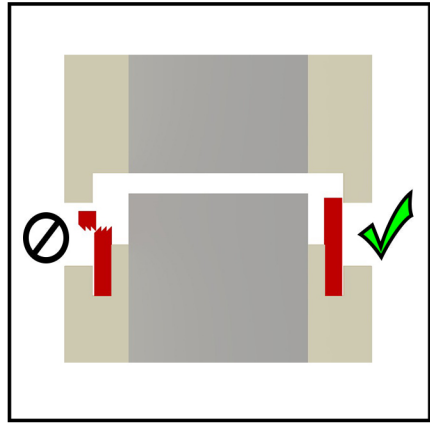

6. Fixing corner post

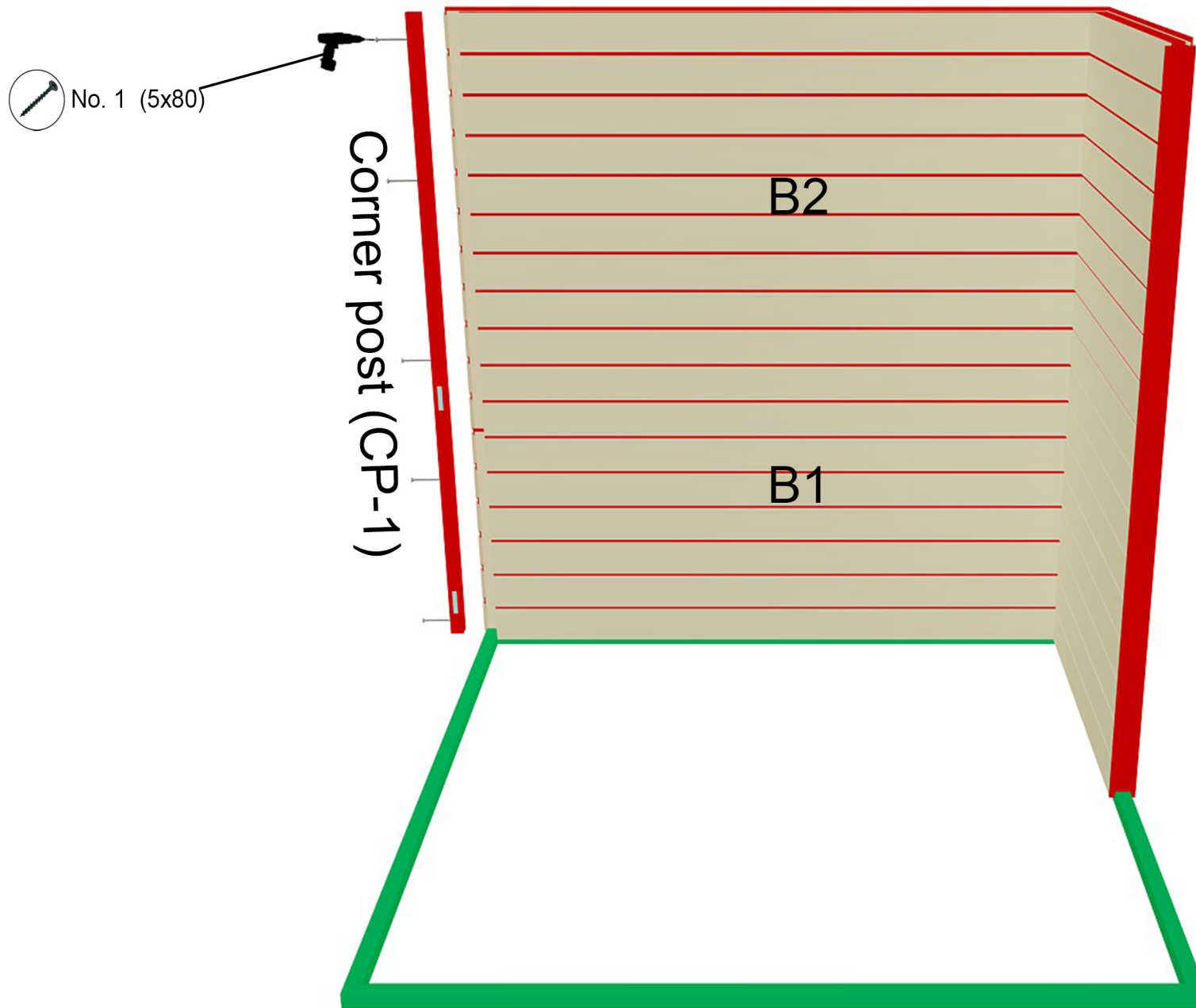

7. Fixing walls C1&C2

No. 1 (5x80)

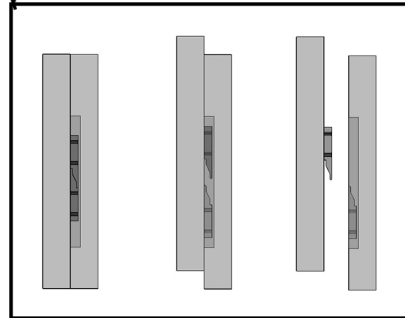
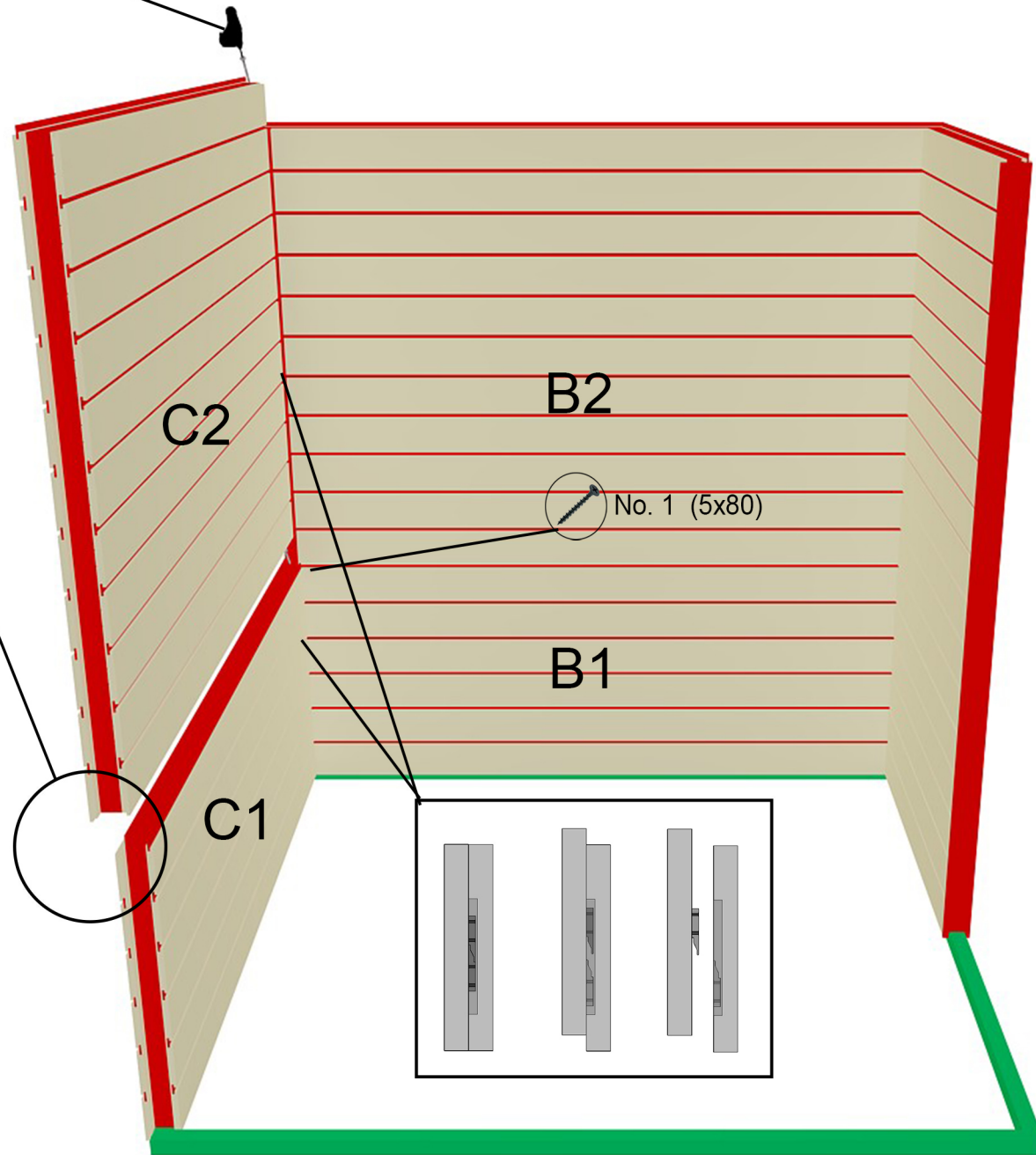
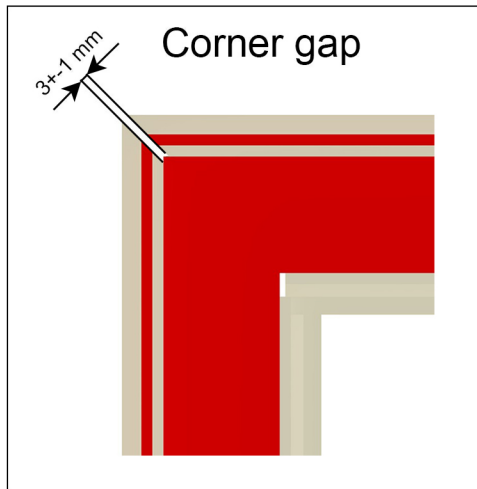
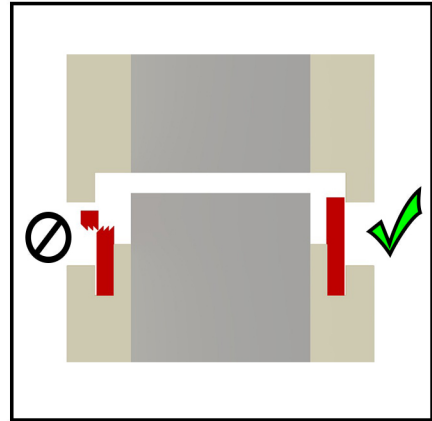

8. Fixing ceilings

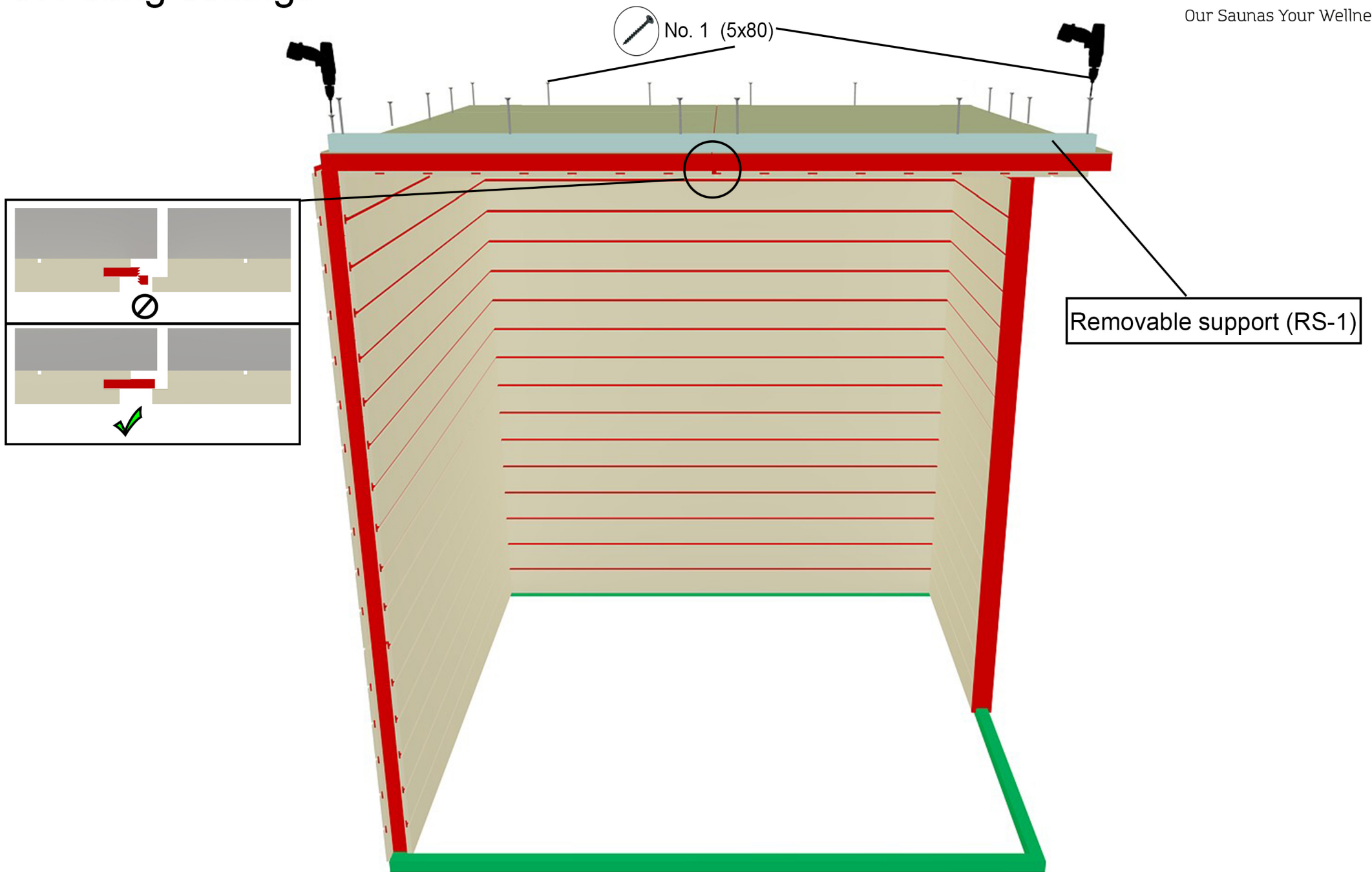

9. Fixing wall A1

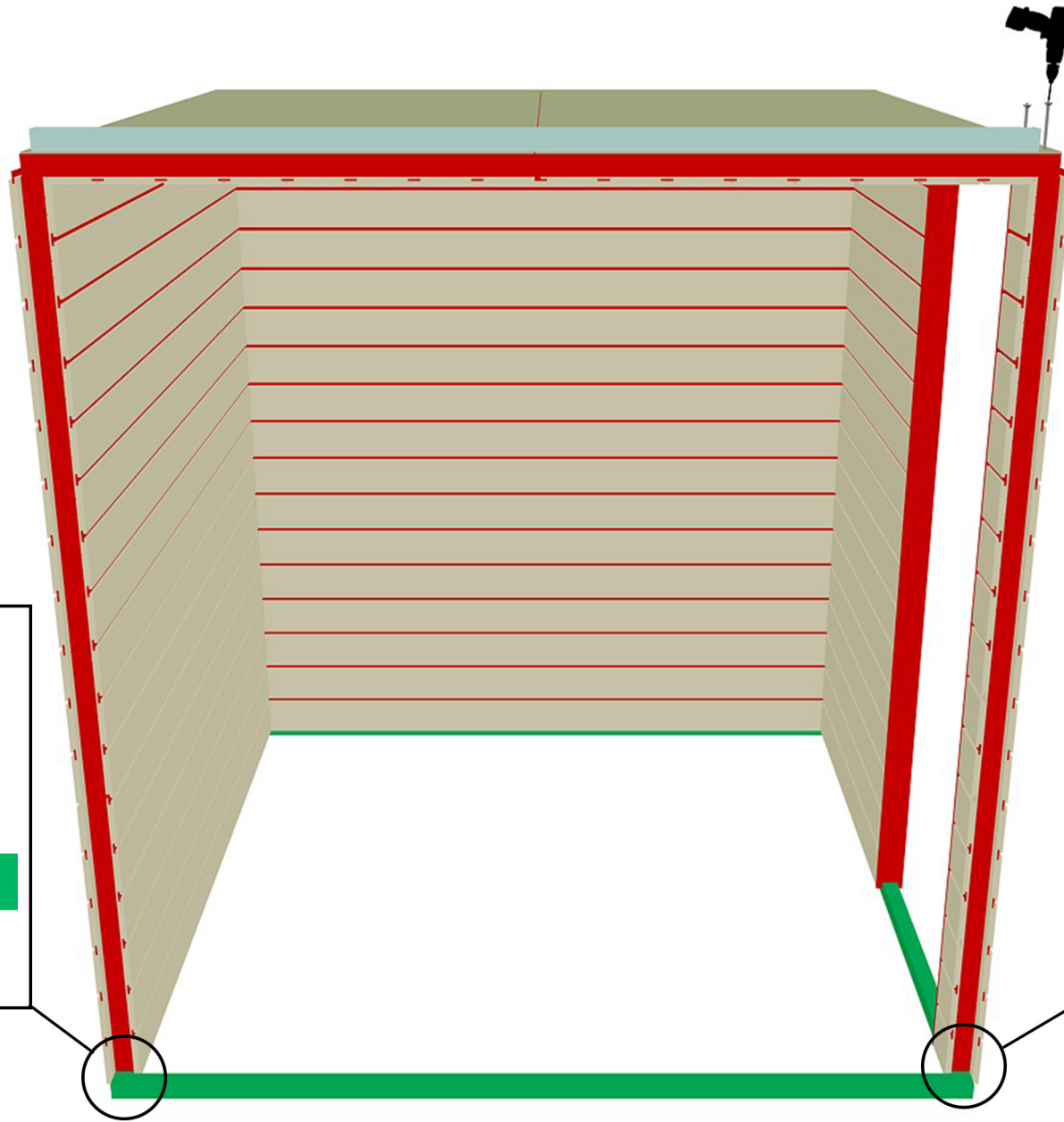

⌀ No. 1 (5x80)

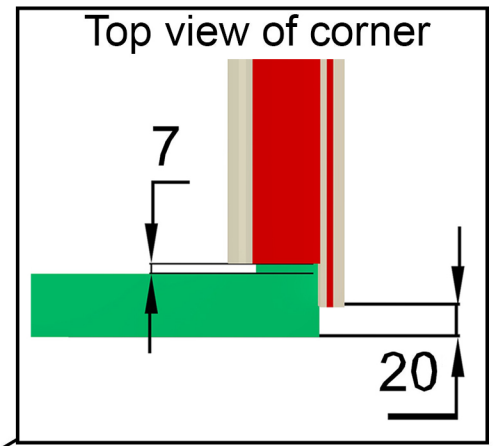
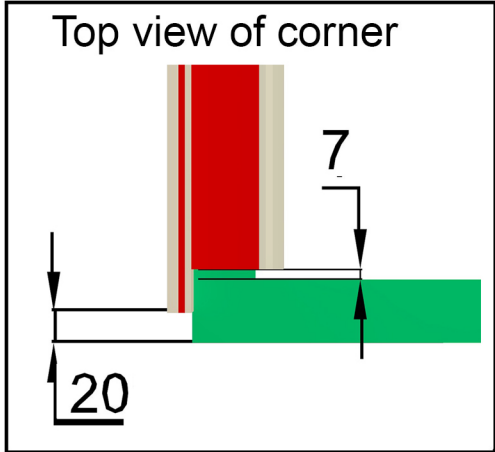

10. Wireing inside walls

1. Push down wires from precut holes on ceiling



2. Pull out wires from precut holes in the walls

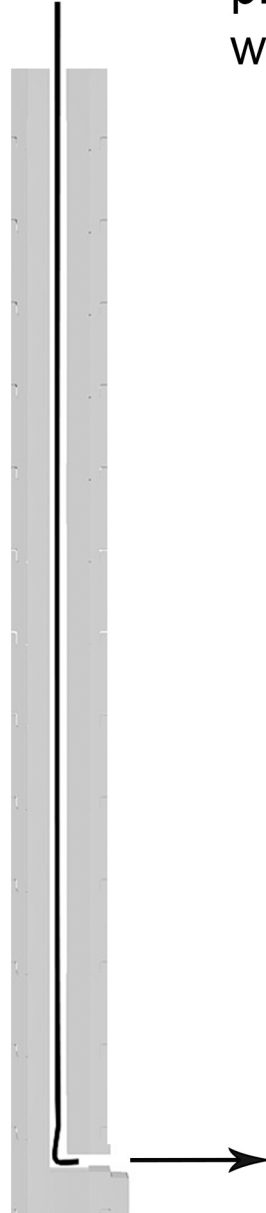

3. Connect wires

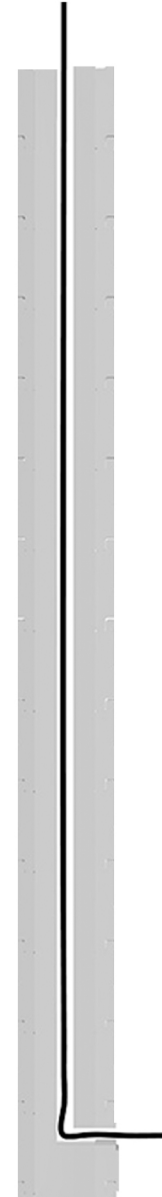

11. Interior

200x200 cm

200x250 cm

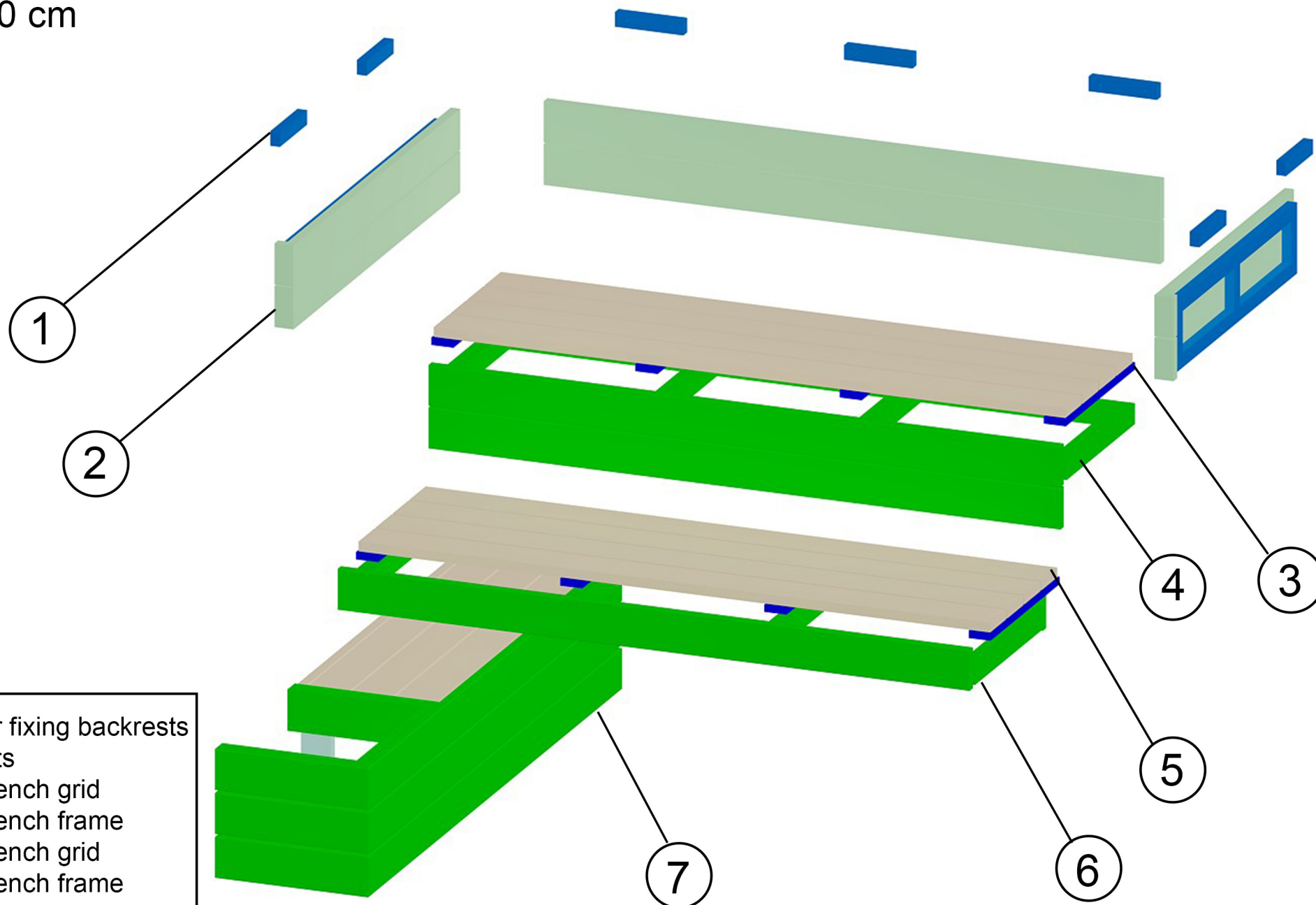

- 1. Block for fixing backrests
- 2. Backrests
- 3. Upper bench grid
- 4. Upper bench frame
- 5. Lower bench grid
- 6. Lower bench frame
- 7. Platform

11.1 Assembly of platform

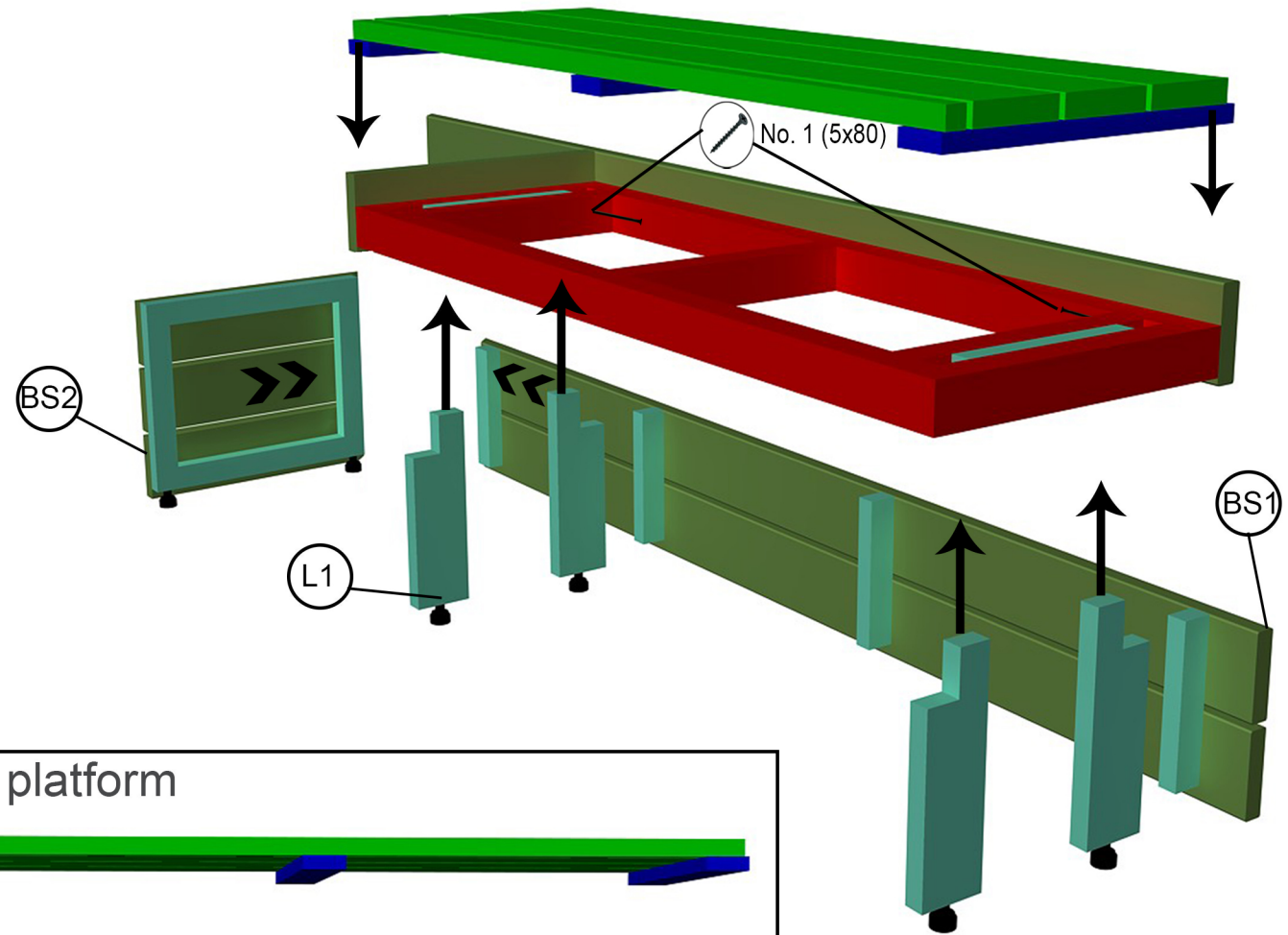

Fixing platform

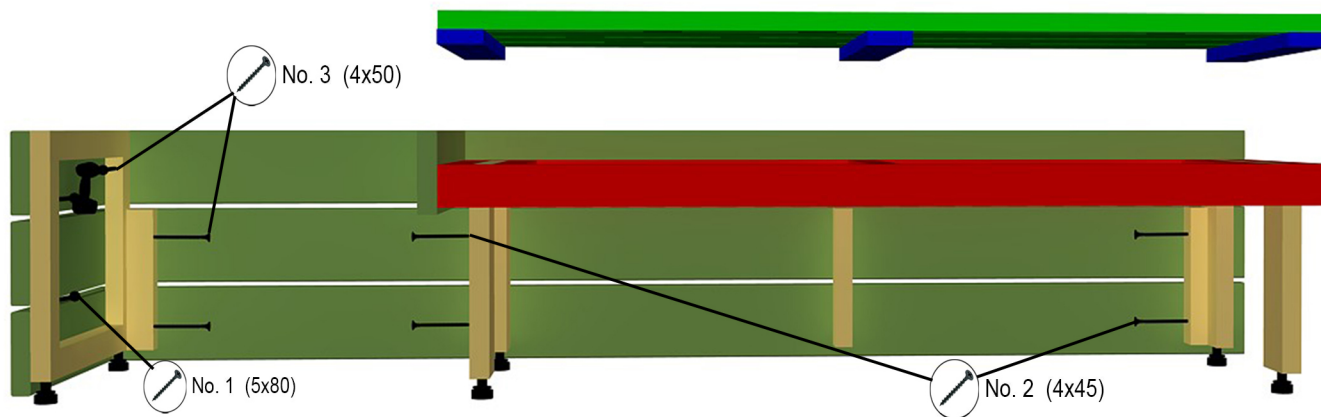

11.2 Upper bench frame & blocks for backrest

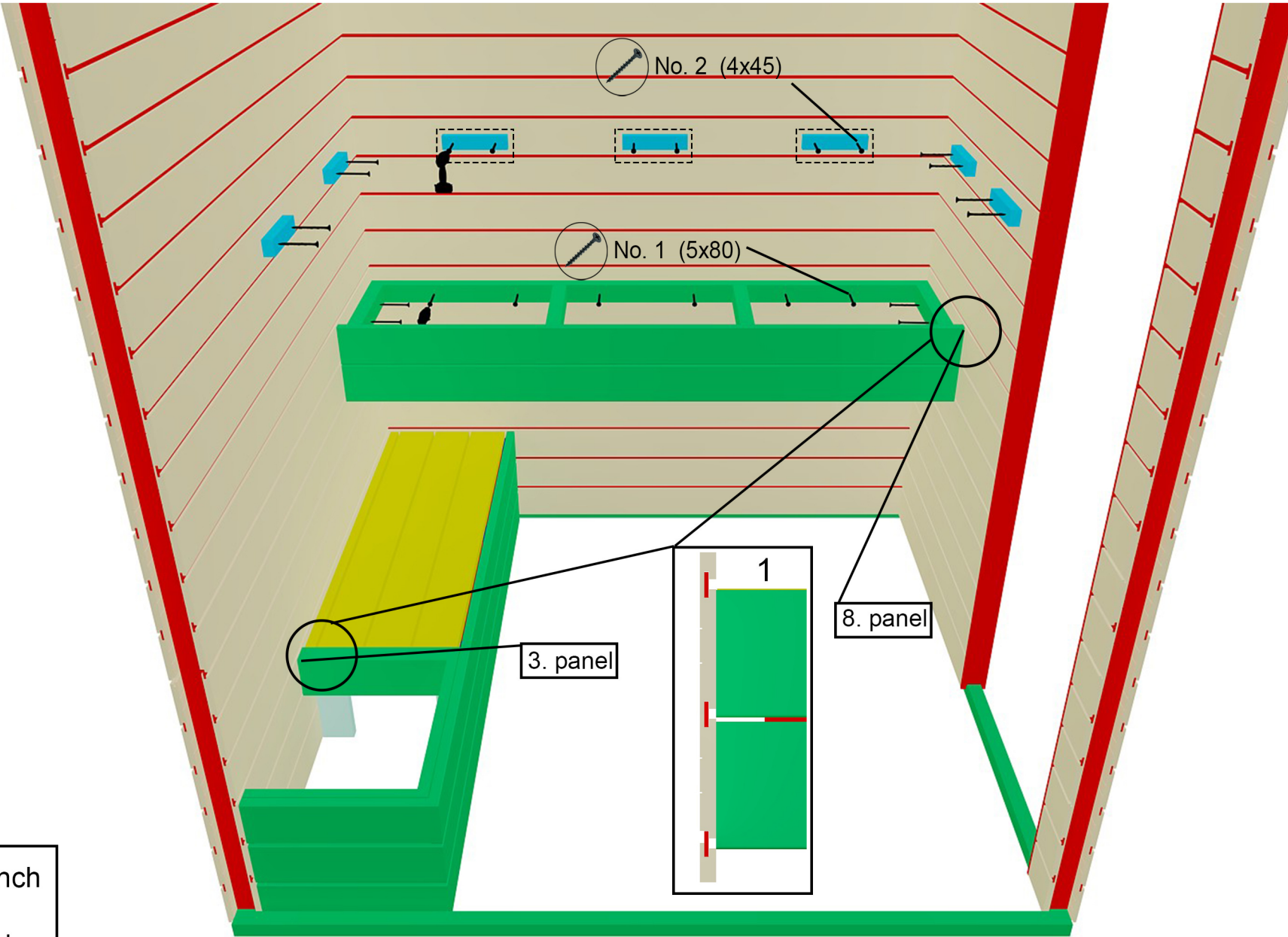

1. Frontside of the bench frame & platform have to be same level with paneling as shown

11.3 Cariitti optic fibre for upper bench (Optional)

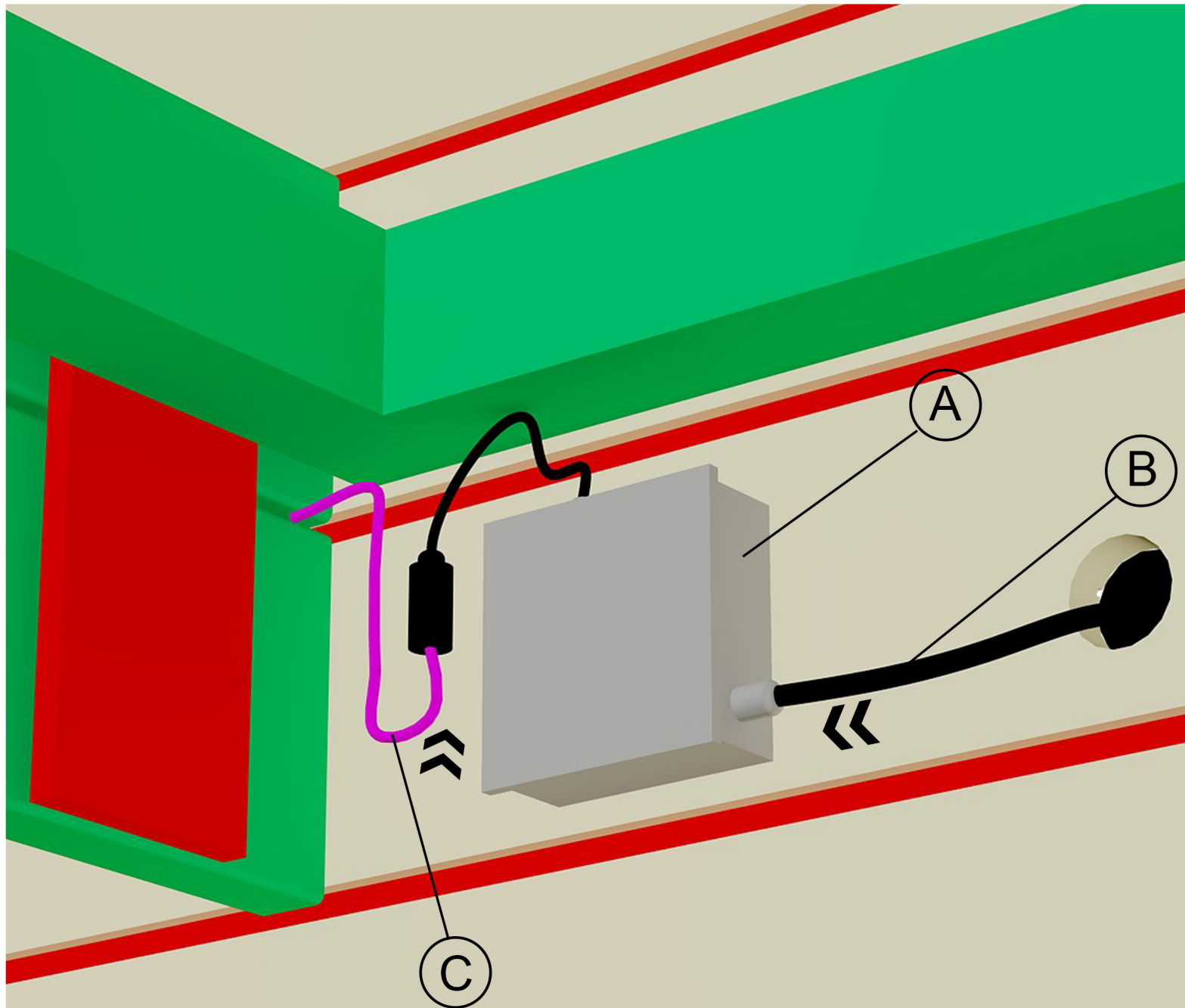

- A. Projector
- B. Power cable
- C. Fibre

1. Push down power cable from the ceiling
2. Connect power cable with projector
3. Push fiber in gap between upper bench frontboards
4. Connect fibre with projector

11.4 Lower bench frame fixing

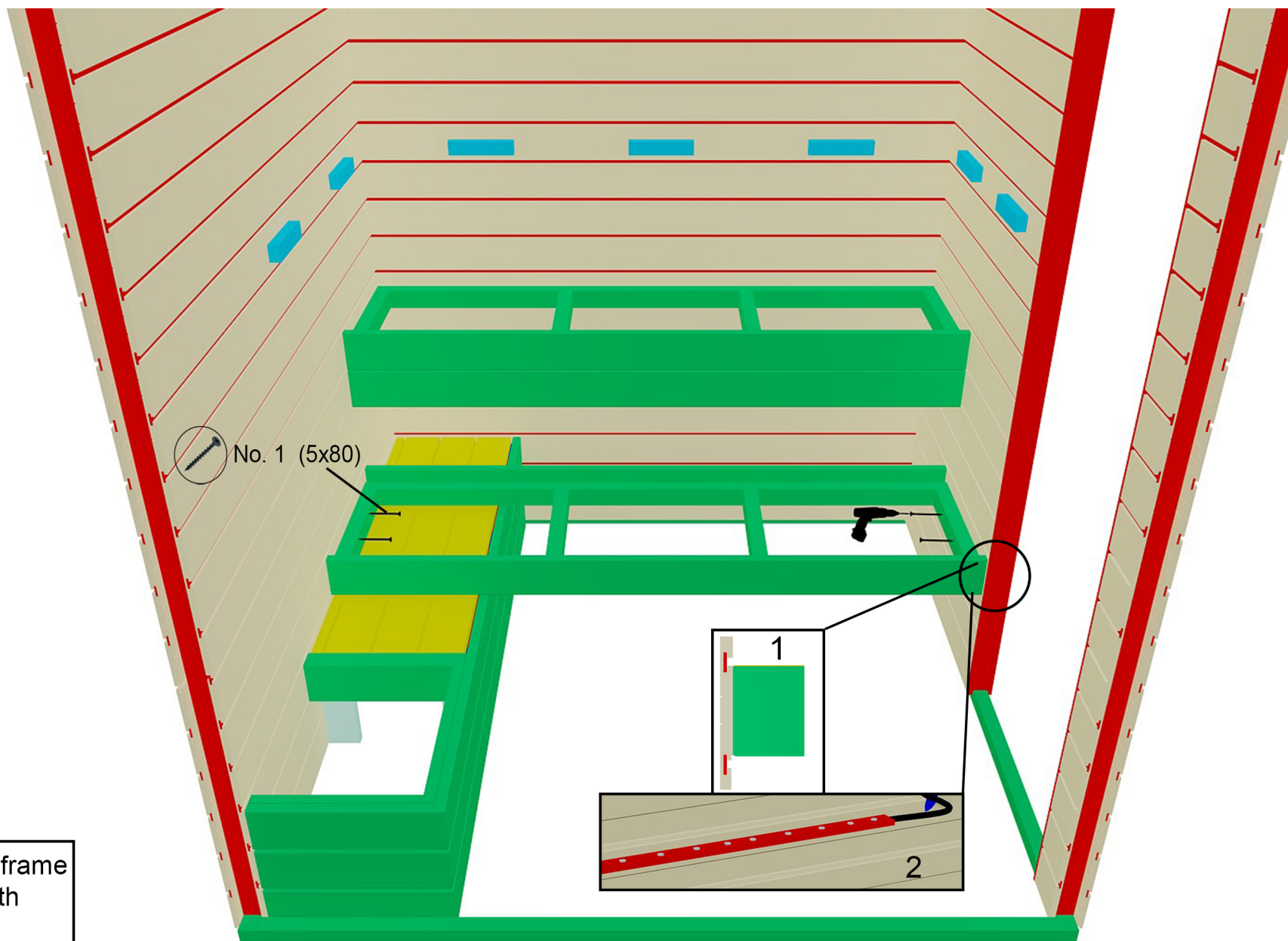

1. Frontside of the bench frame have to be same level with paneling as shown
2. Push LED-strip cable to ceiling for connection

12. Backrest LED-strips

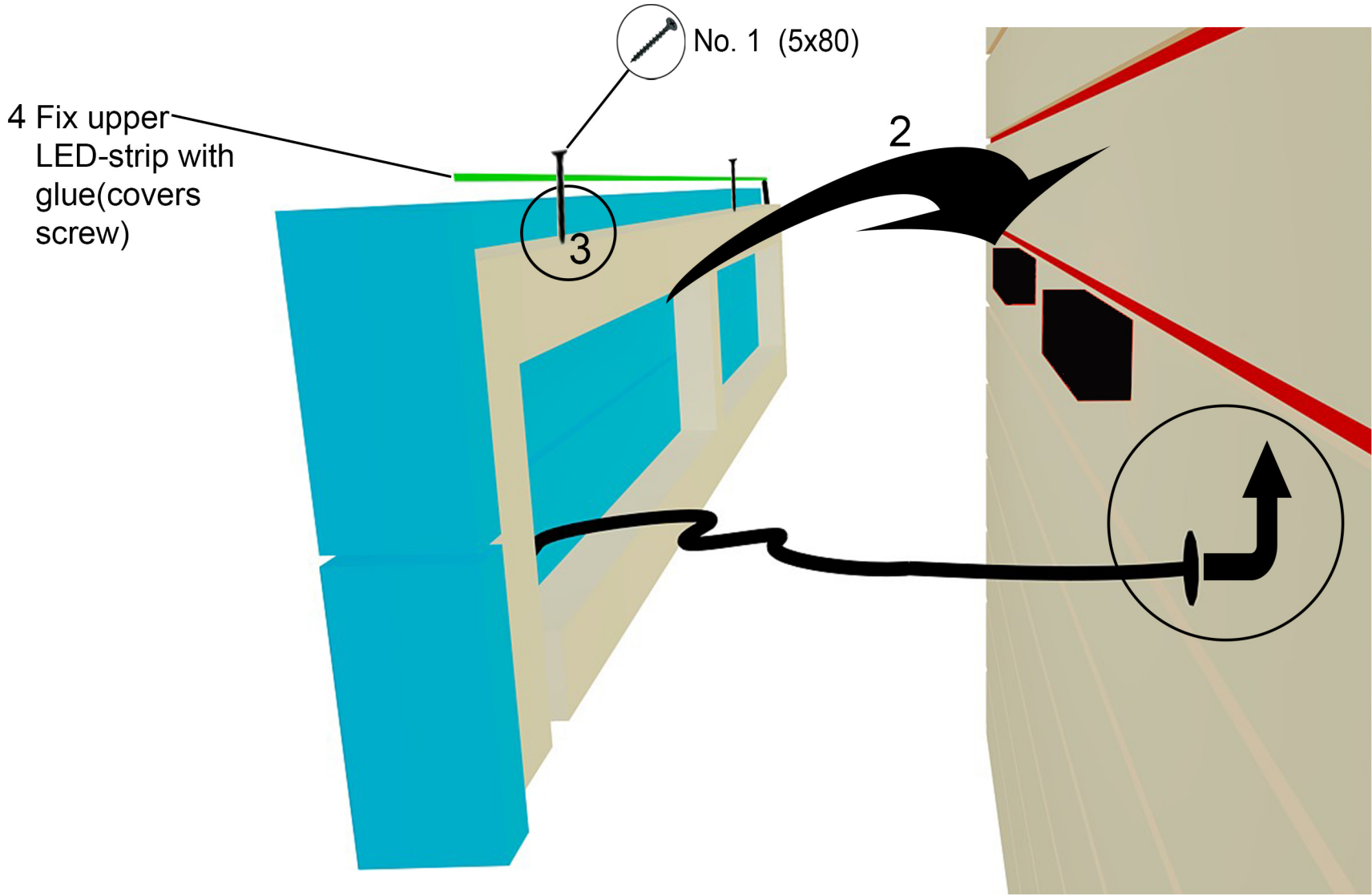

12.1 Fixing backrests

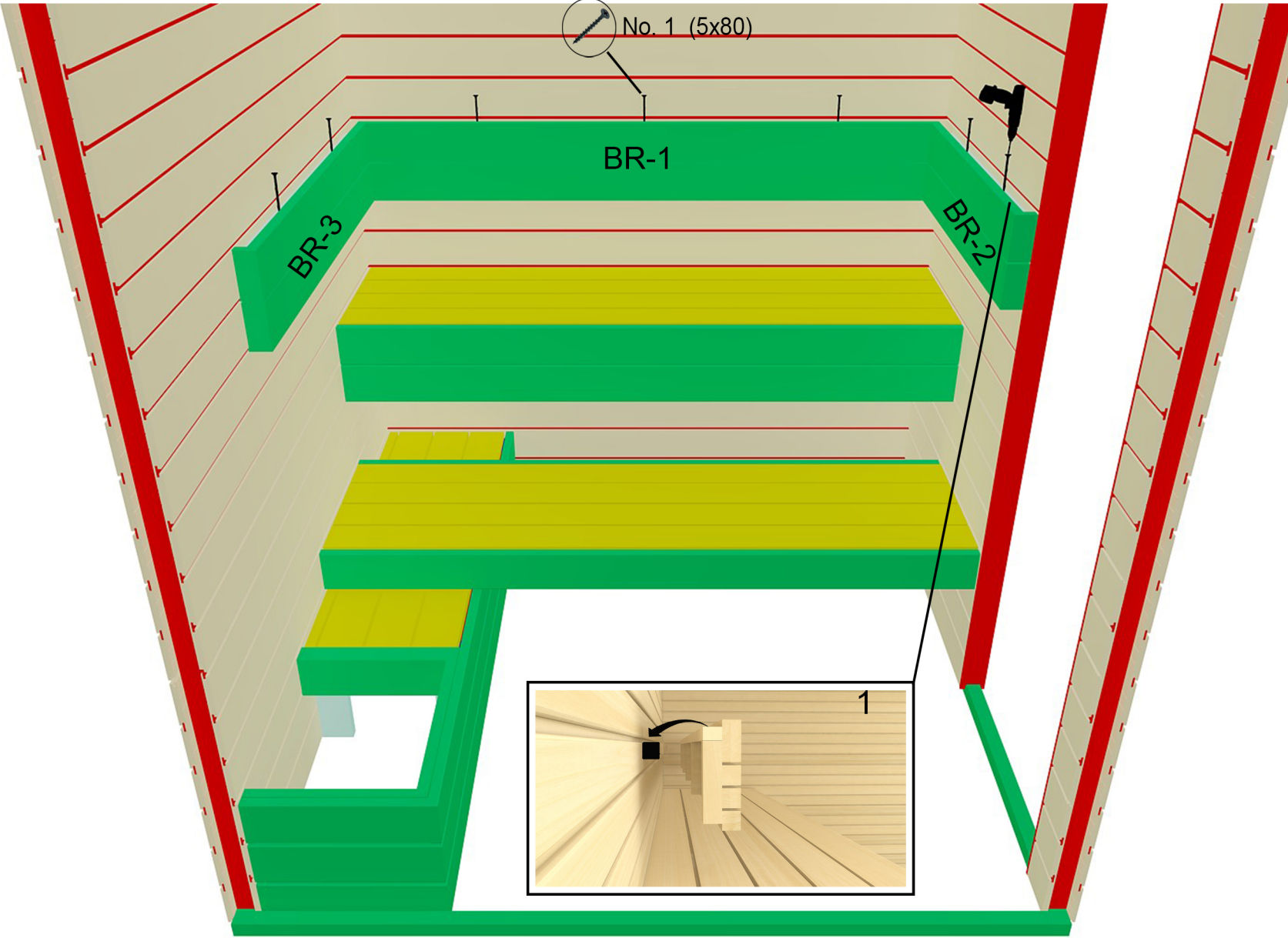

13. Interior II
200x200 cm
200x250 cm

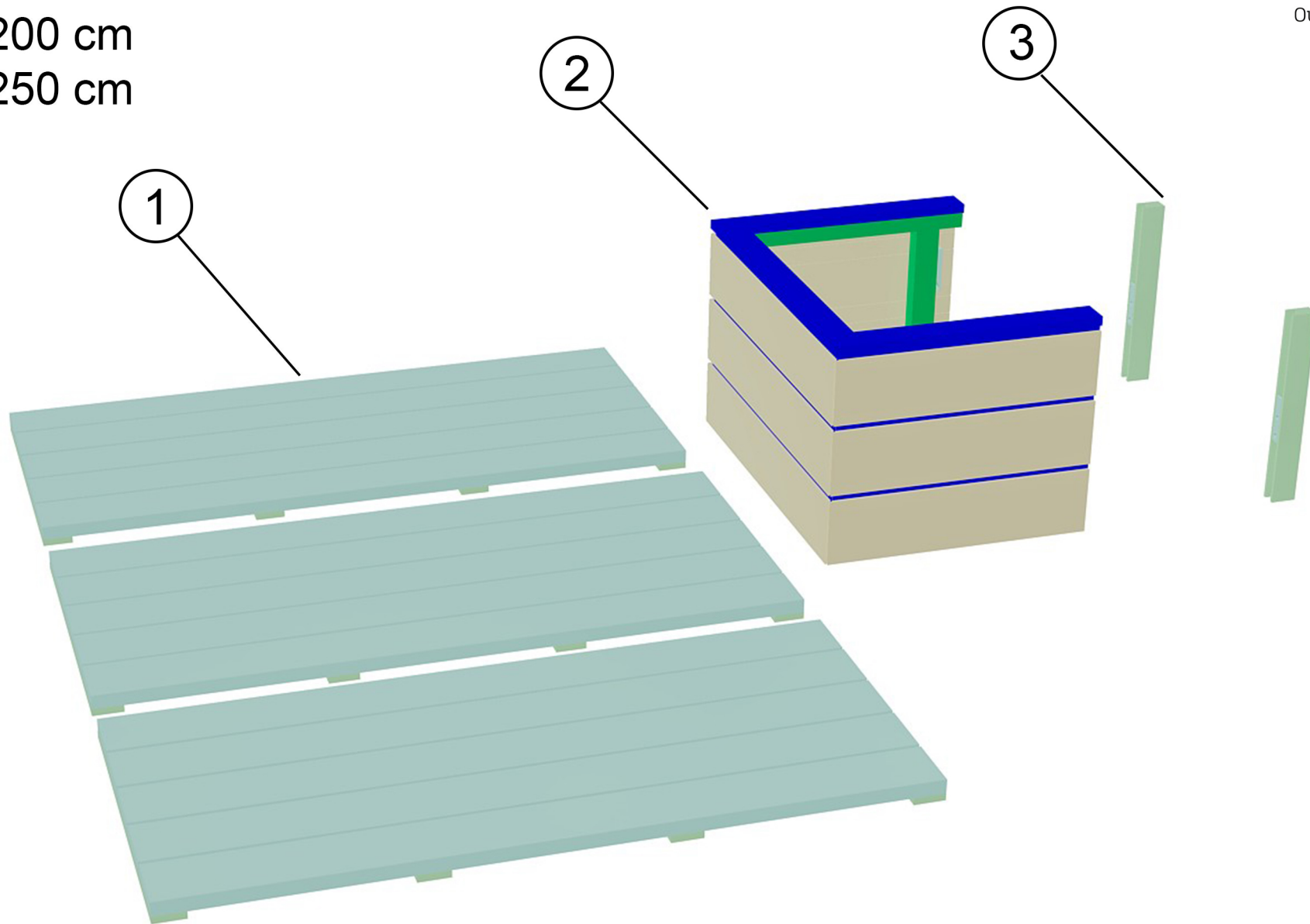

- 1. Floor grids
- 2. Heater guard
- 3. Heater guard holders

14. Fixing heater guard

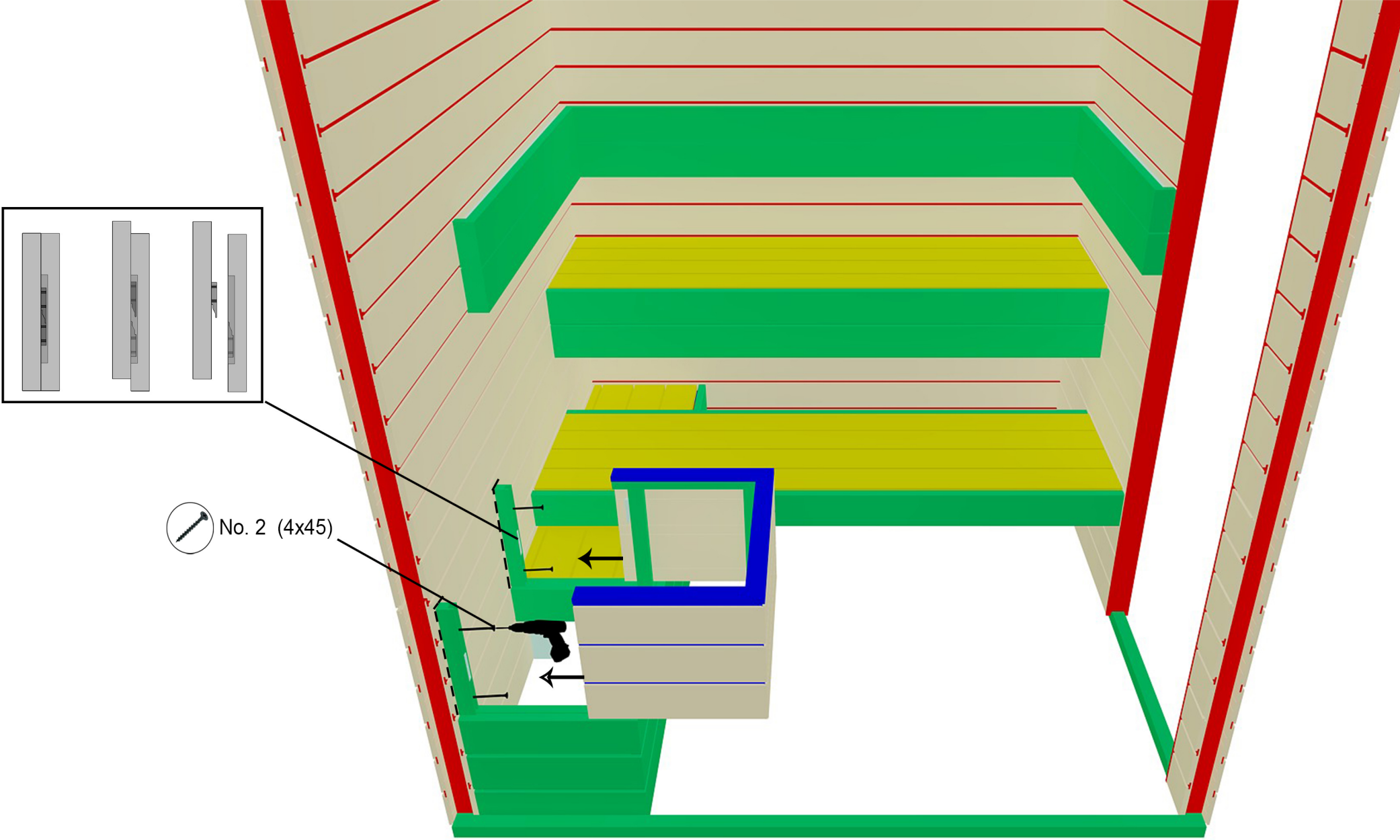

15. Glass wall

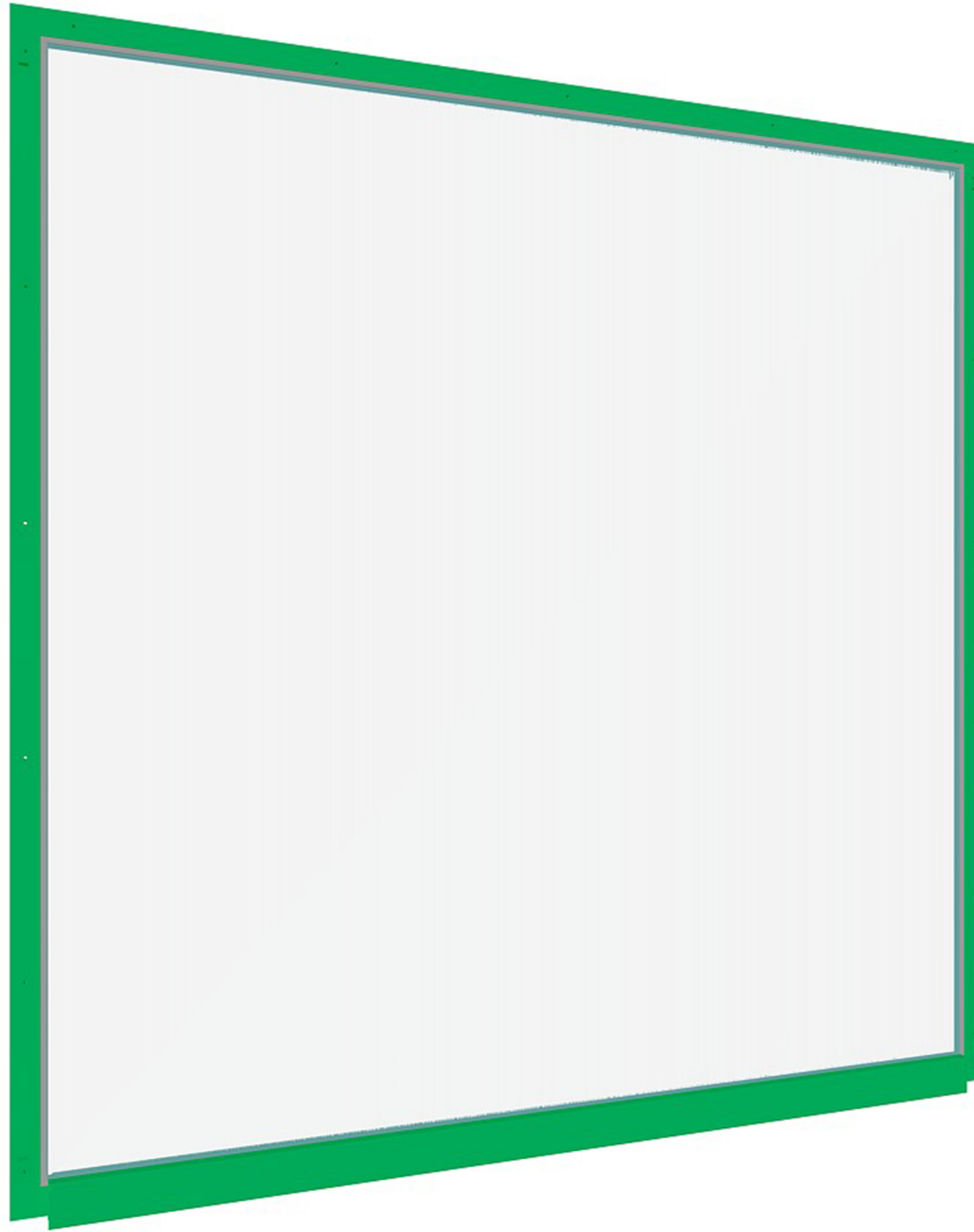

16. Fixing glass wall

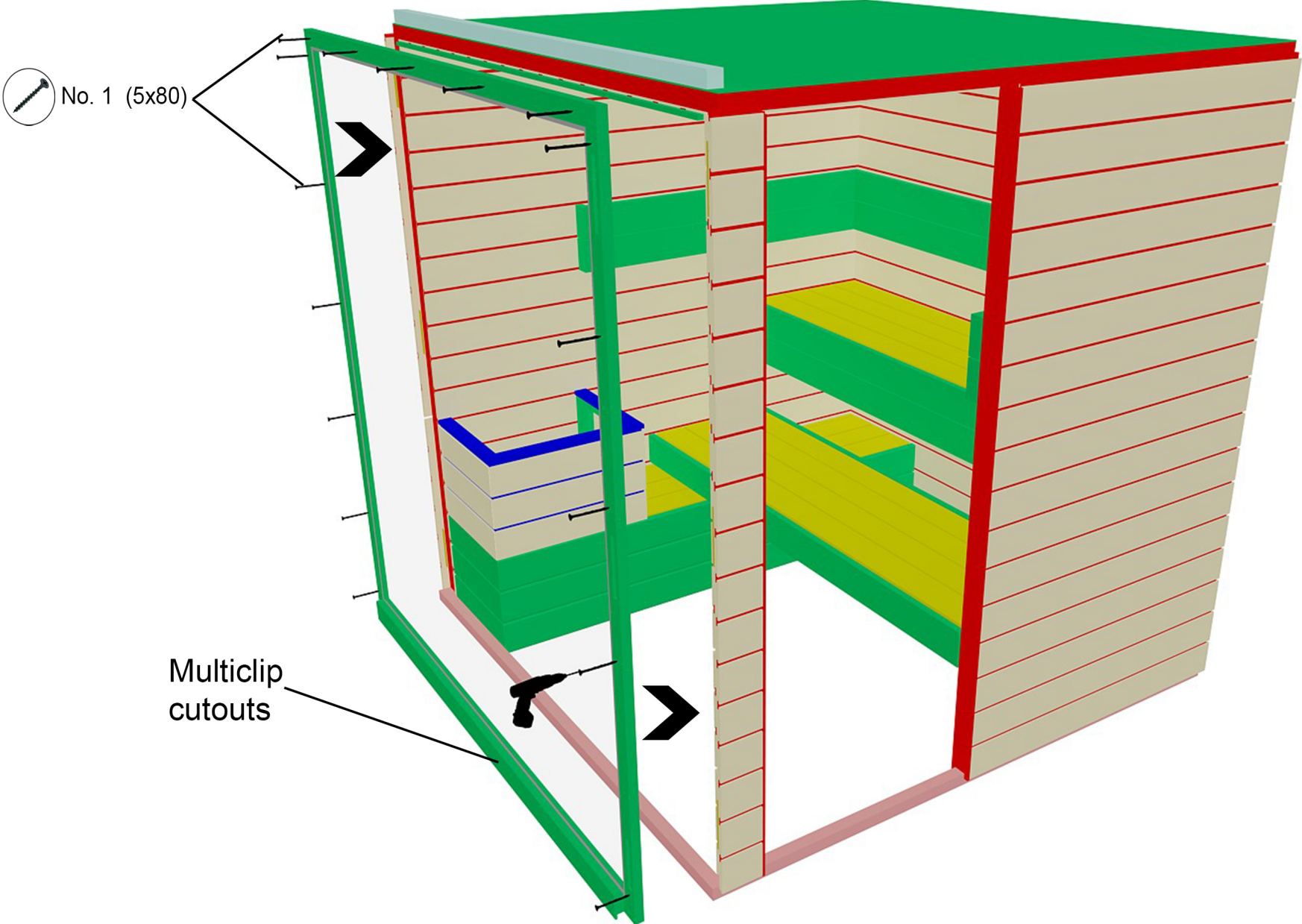

16.1 Multiclips for glass wall

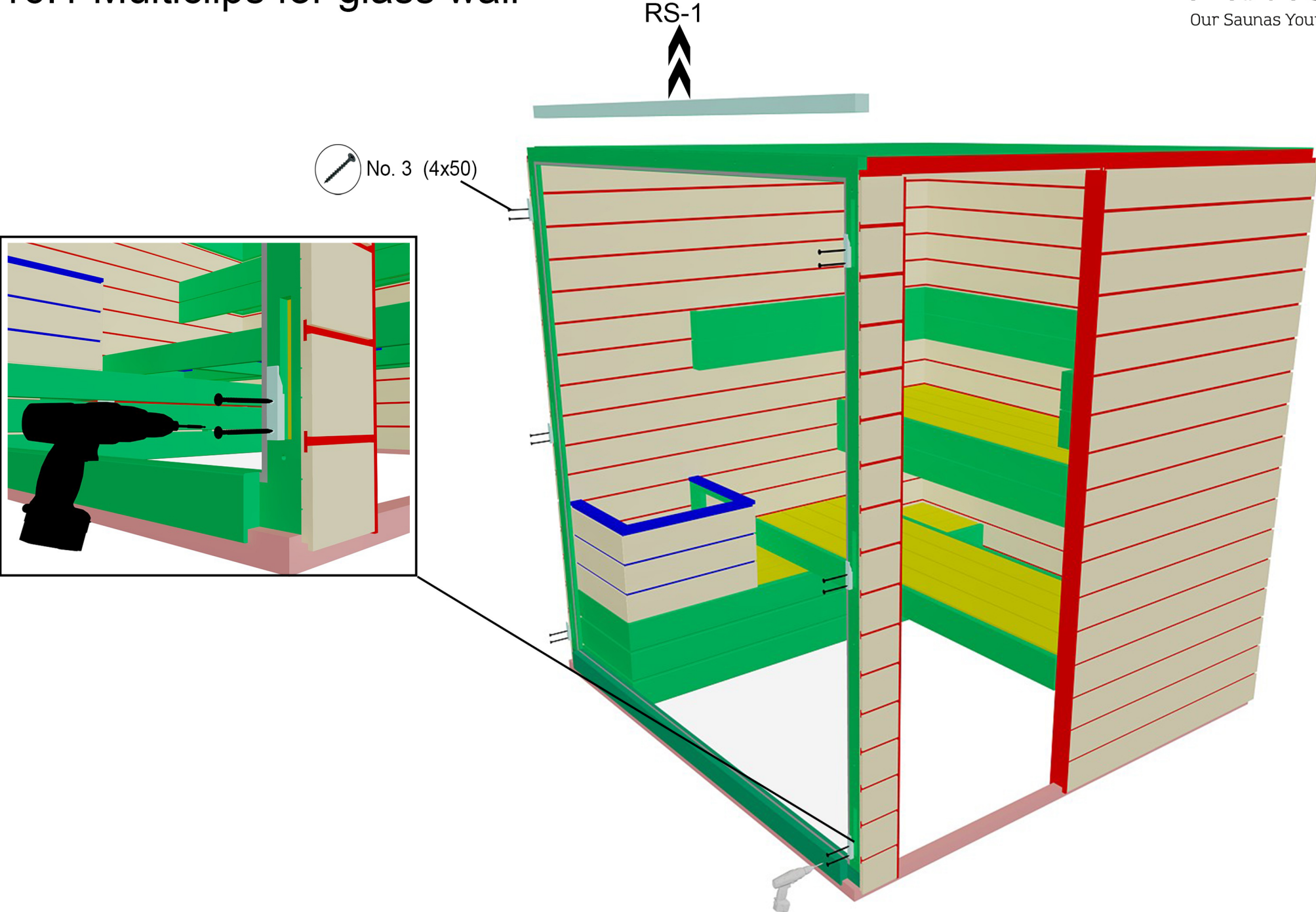

17. Upper frame

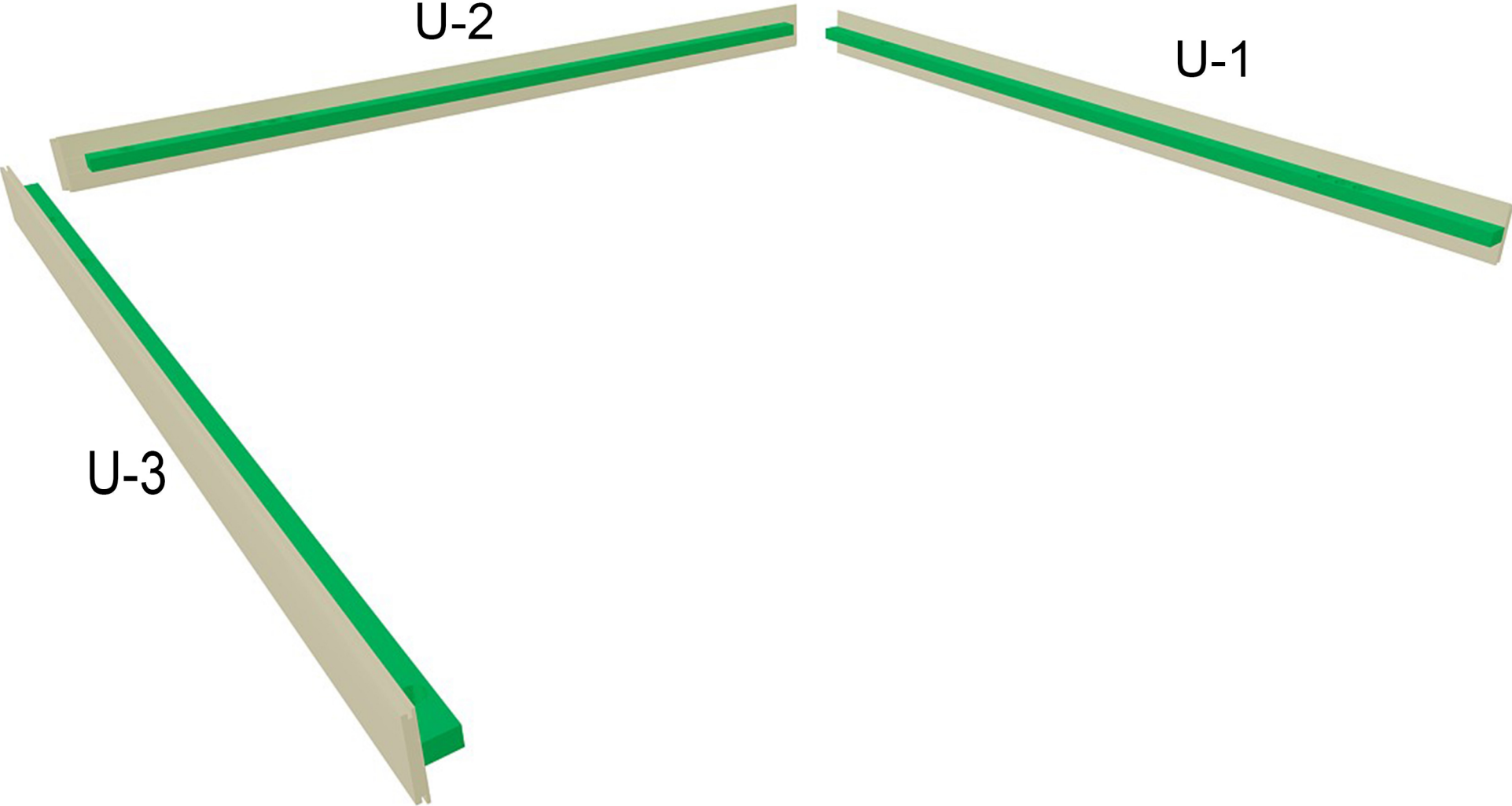

18. Fixing upper frame

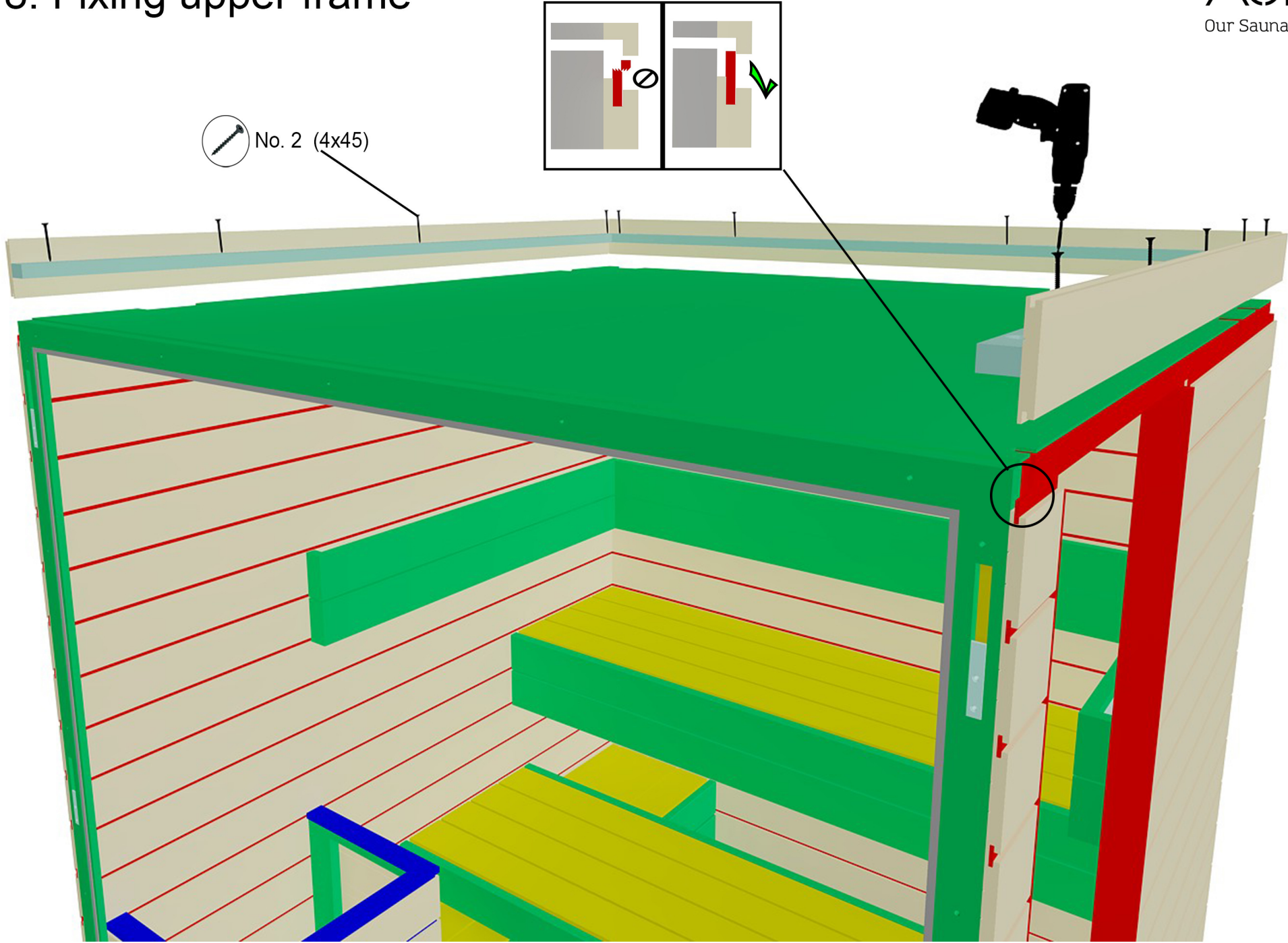

19. Front frame

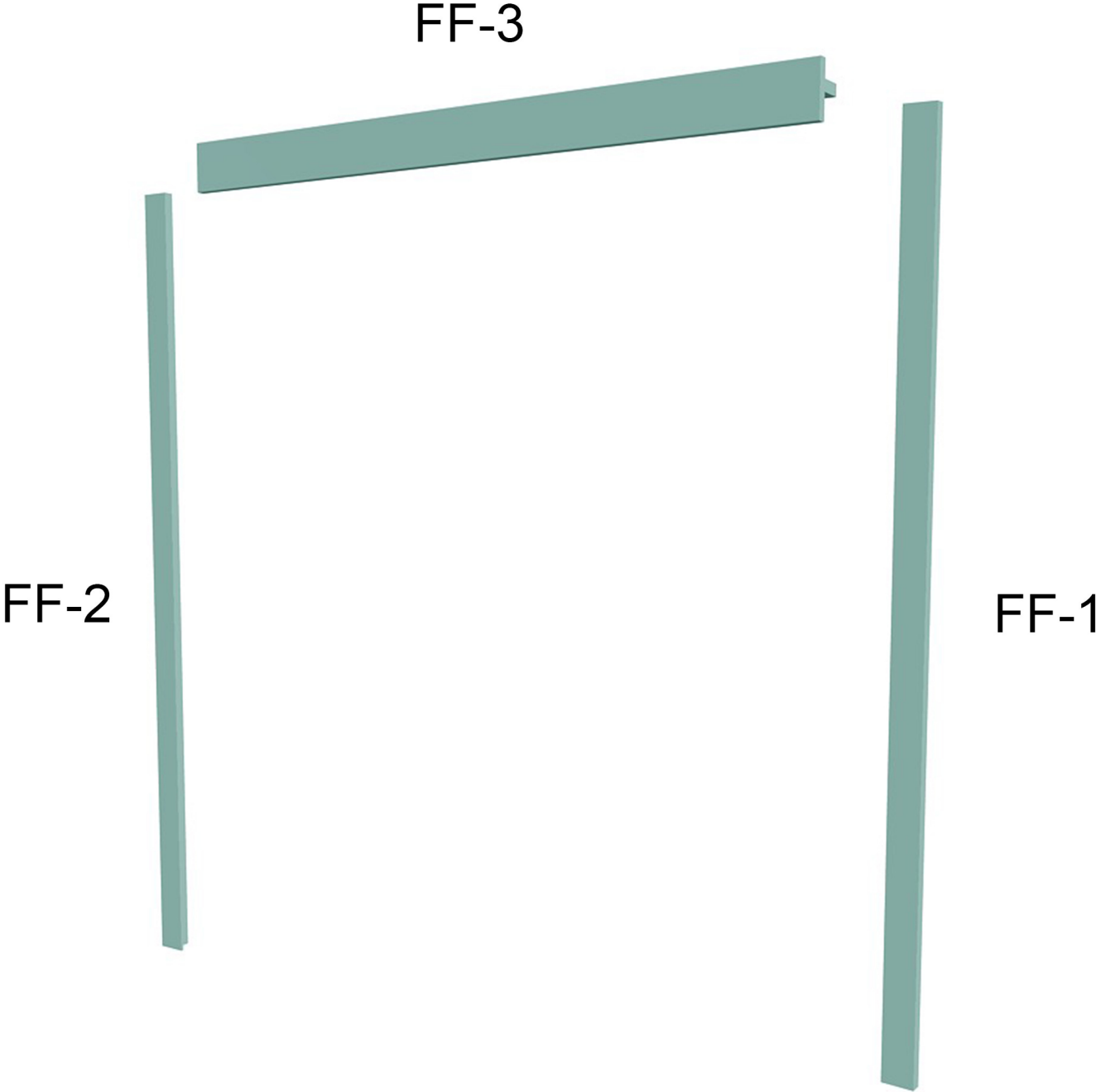

20. Fixing front frame

 No. 2 (4x45)

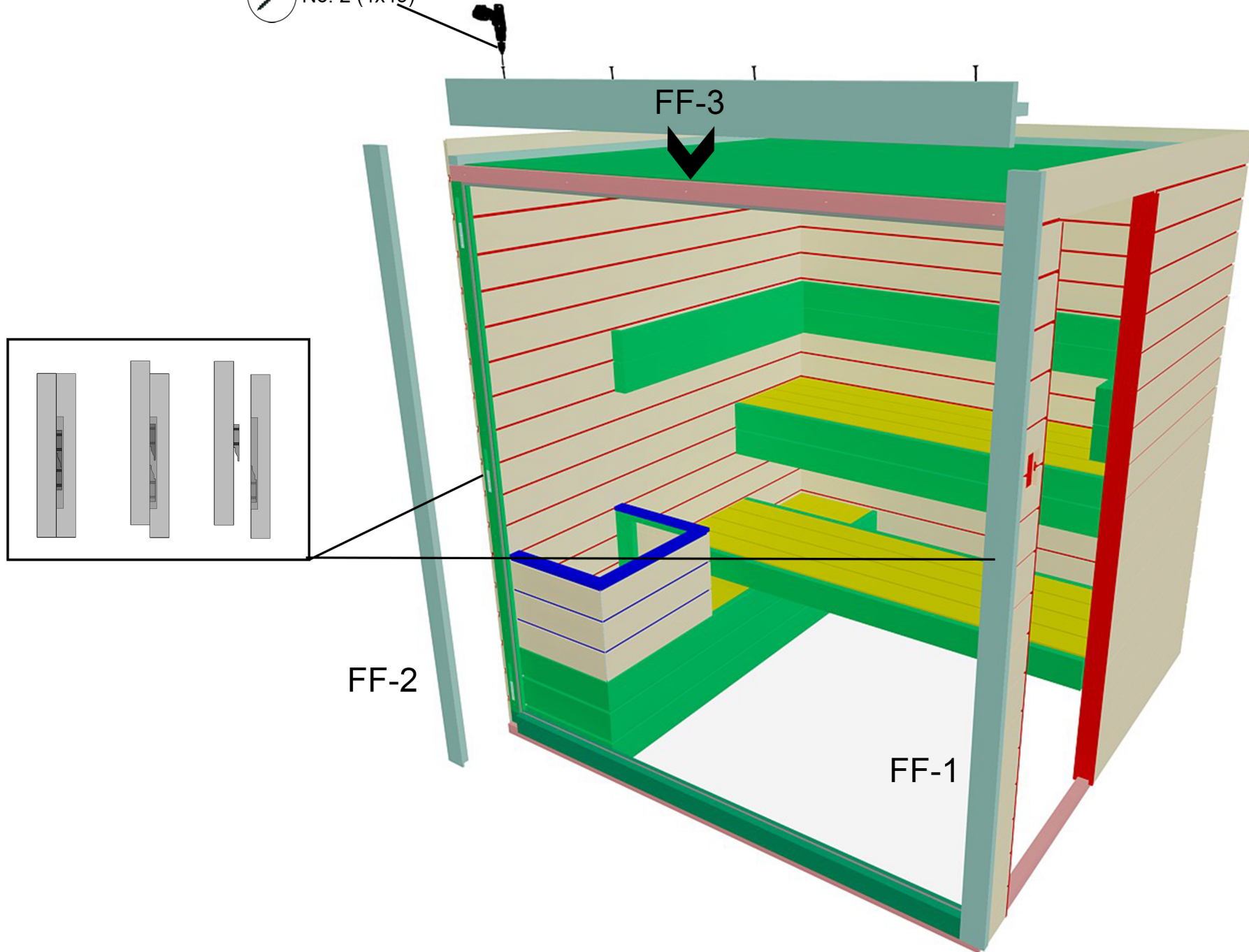

21. Fixing door hinges

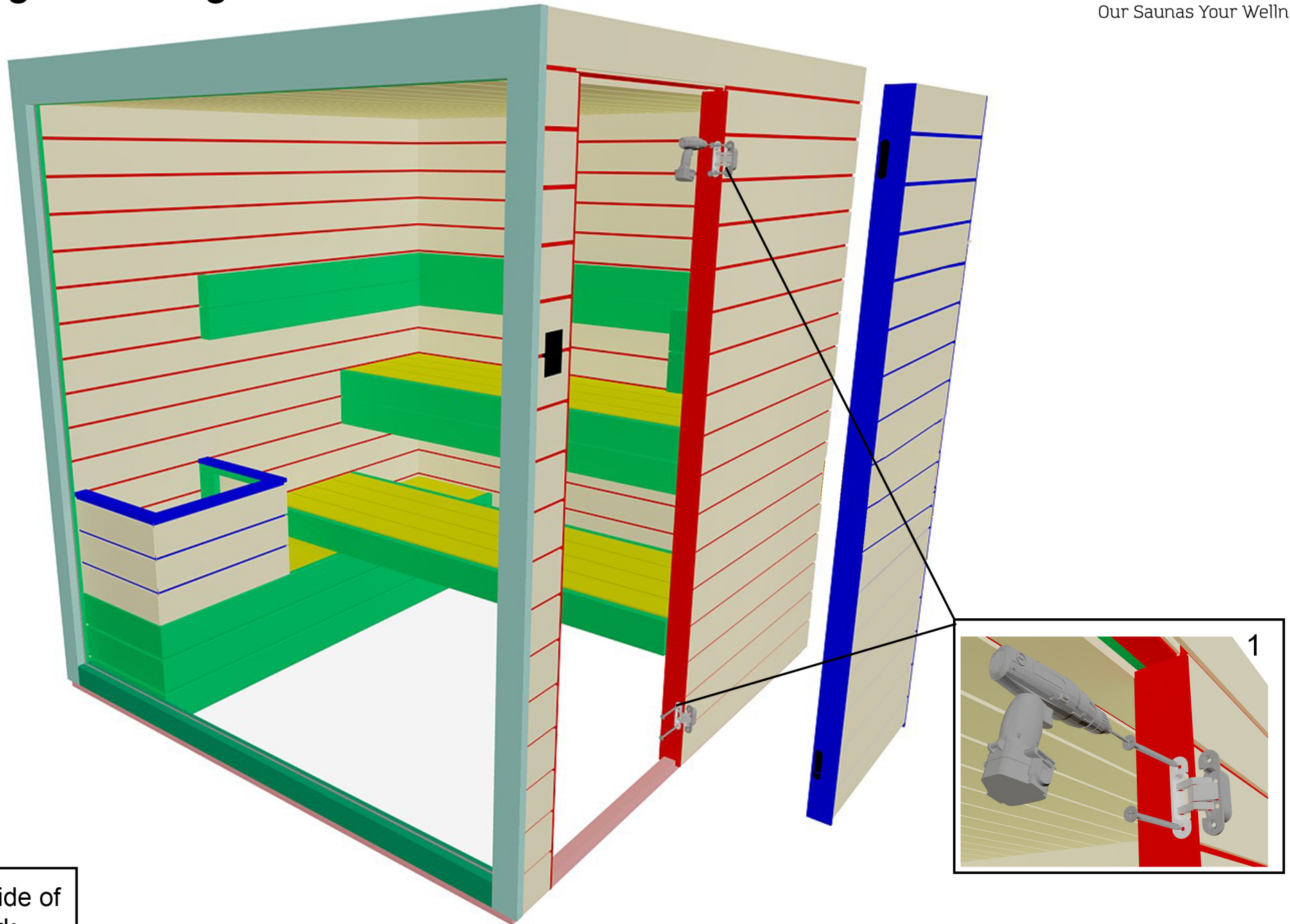

1. Look backside of hinges for mark "doorside"

22. Fixing door

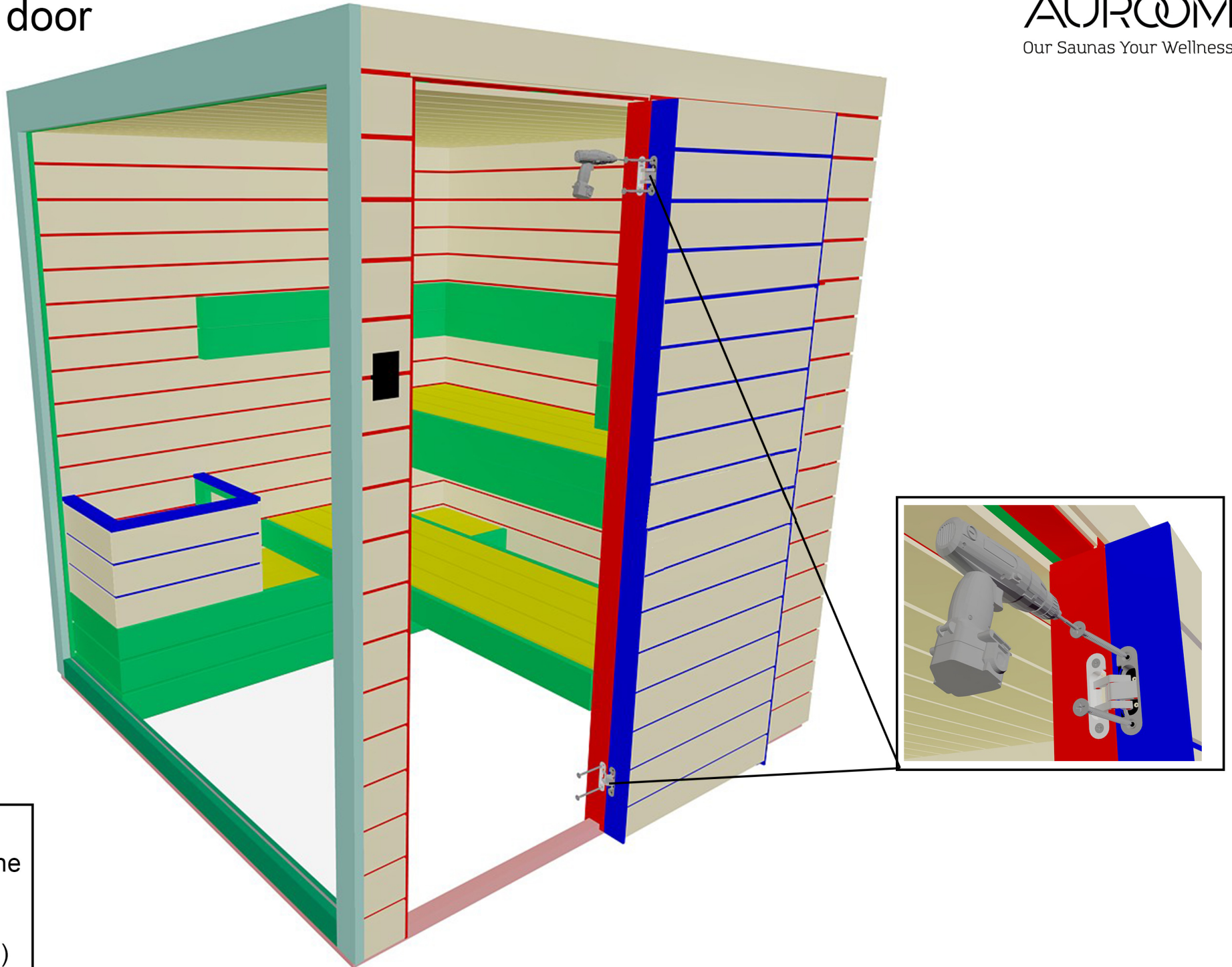

1. Fix hinges in
pre-cut holes in the
door
(Adjustment is in
the hinge manual)

23. Fixing handles

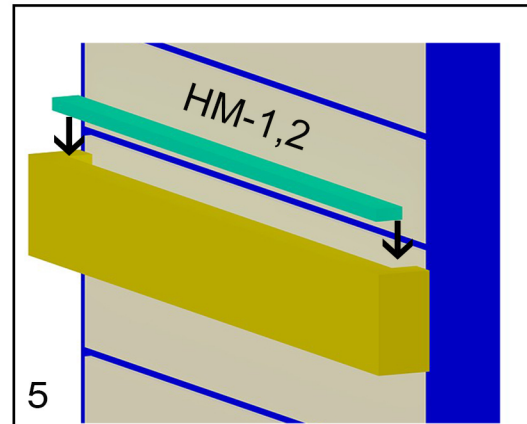
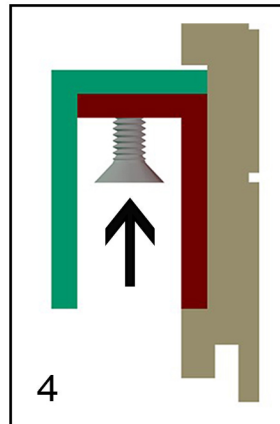
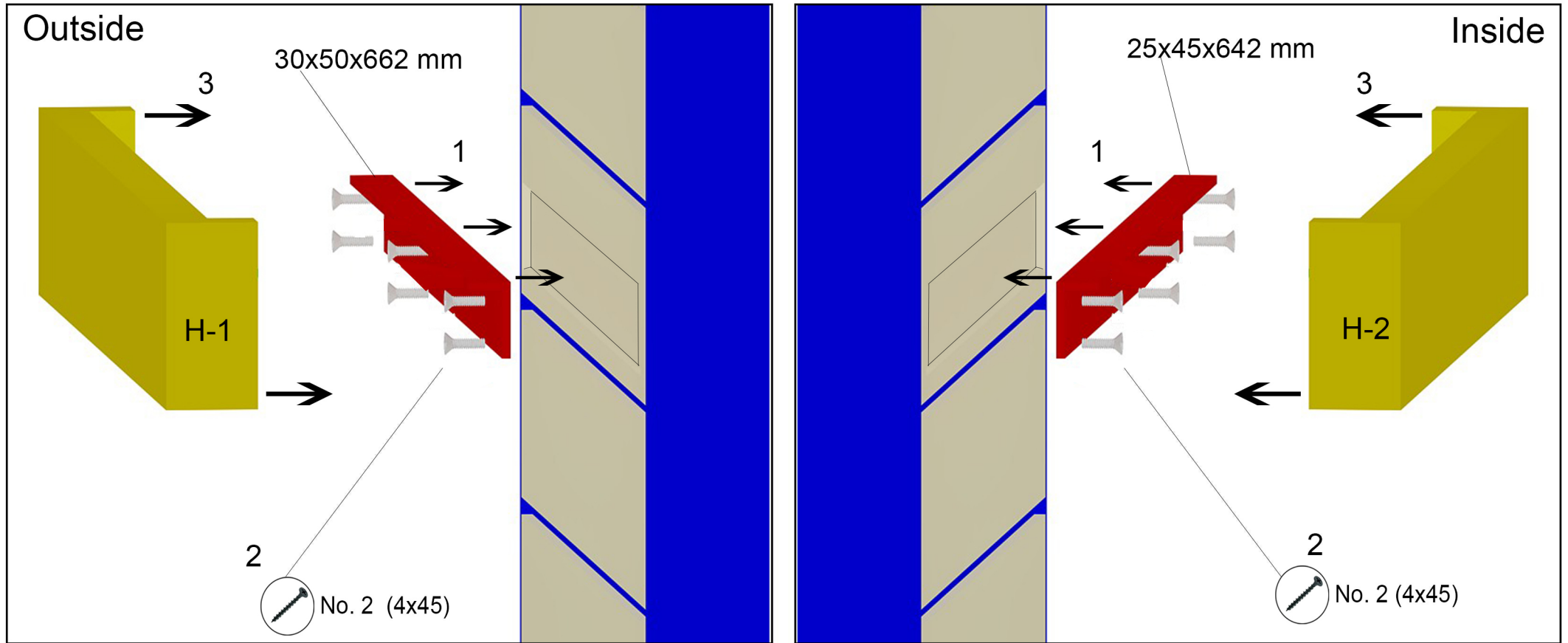

24. Wiring on ceilings

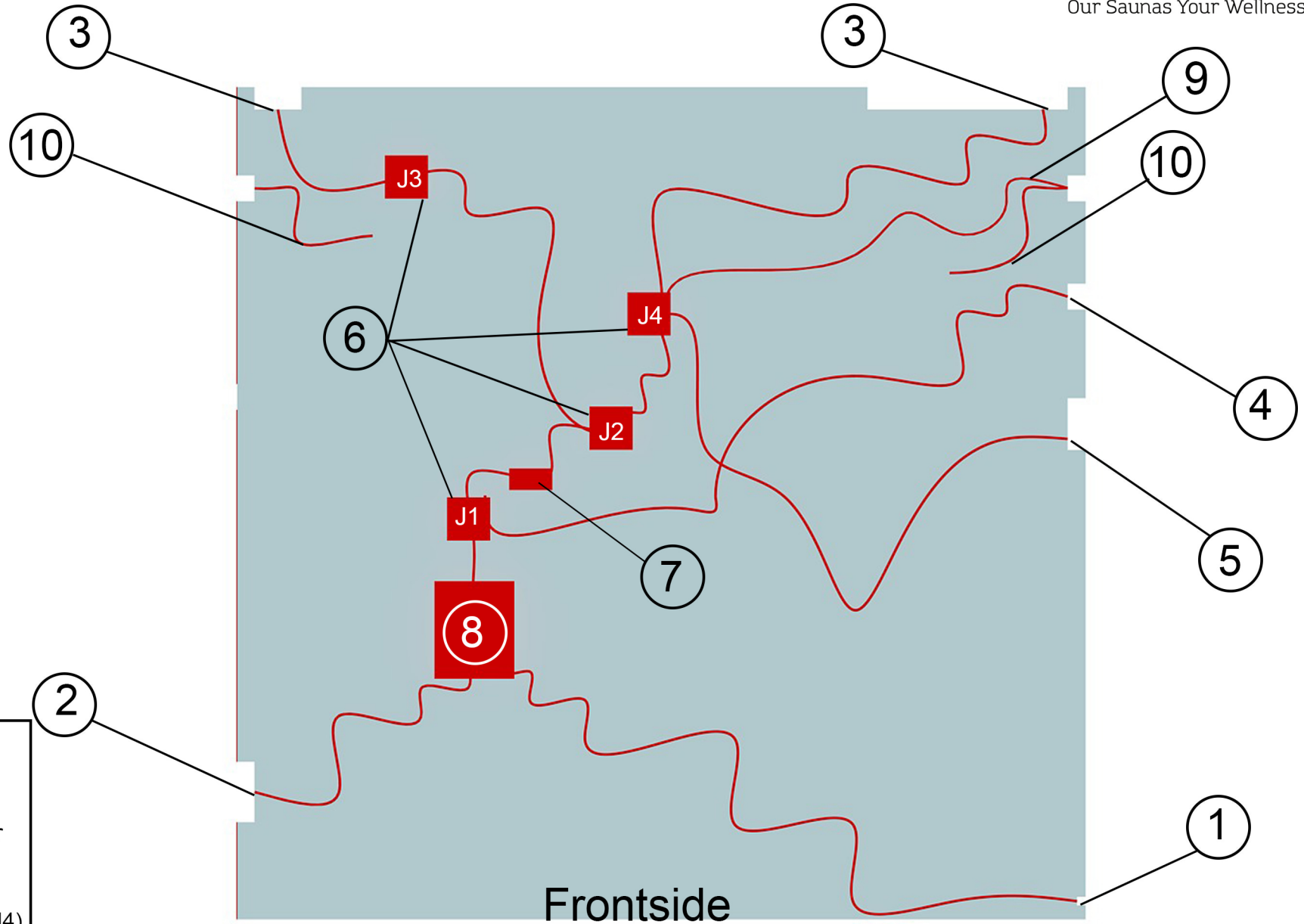

- 1. Control unit cable
- 2. Heater cable
- 3. Backrest LEd-strips
- 4. 230 V for carriti optic fiber (optional)
- 5. Lower bench LED-strip
- 6. Junction boxes (J1,J2,J3,J4)
- 7. Transformer
- 8. Power unit
- 9. Lamp cable (optional)
- 10. Speakers (optional)

Always use certified electrician !